

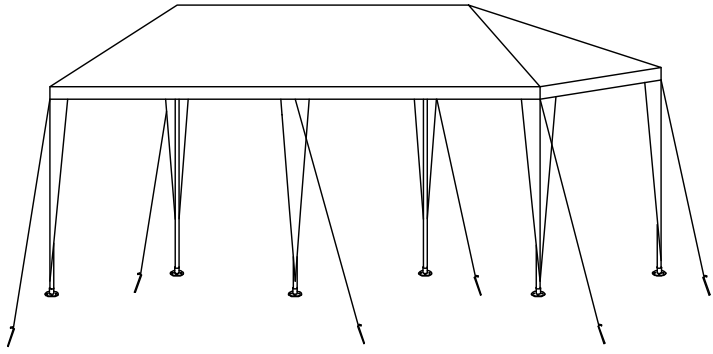









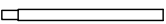
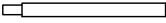

**3 X 6 M**

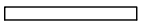

- |   |   |   |  |
|---|---|---|--|
| ① |  X 8  |  X 4 |  X 2  |
| ② |  X 10 |   |  |
| ③ |  X 12 |  X 2 |  X 6  |
| ④ |  X 6  |  X 6 |  X 12 |
| ⑤ |  X 6  |   |  |
| ⑥ |  X 6  |  X 1 |  |
| ⑧ |  X 1  |   |  |

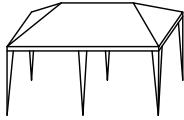