

ASPEN

ASPEN 08

OP-316

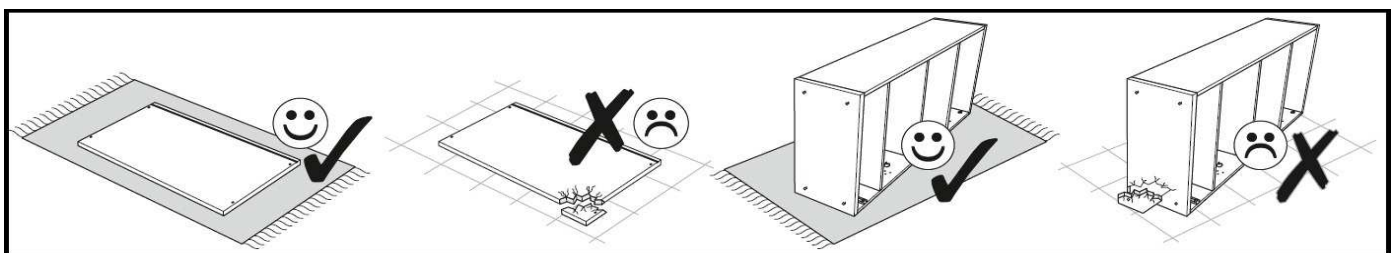
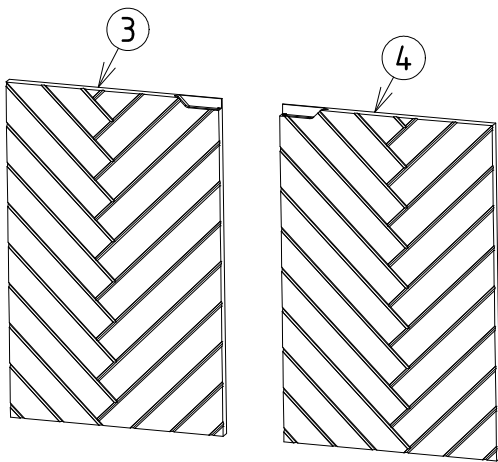
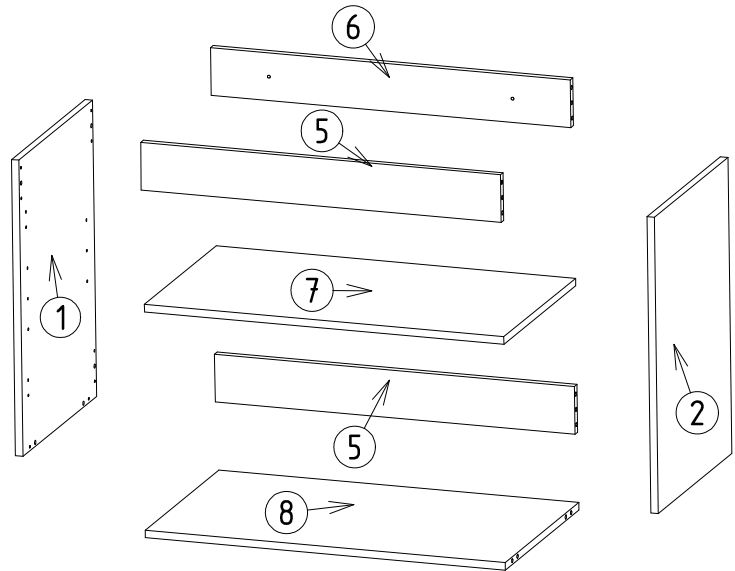
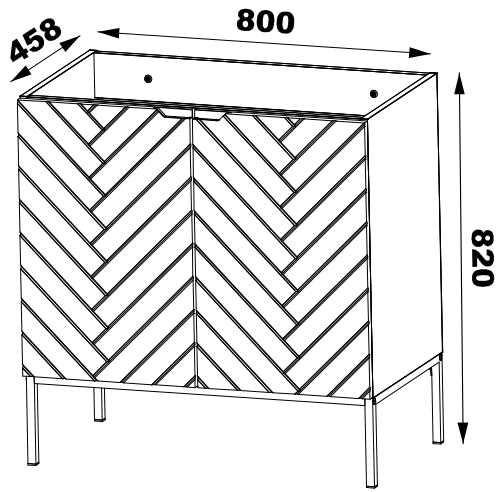

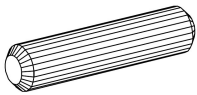

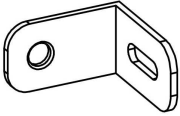

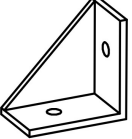

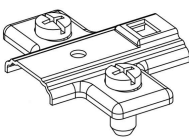
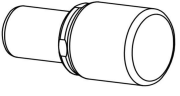
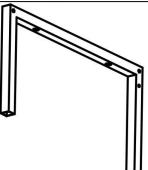
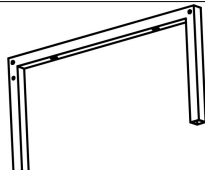
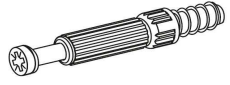
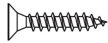

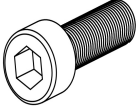
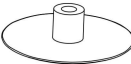
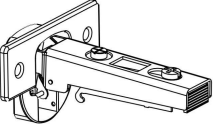
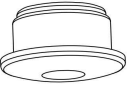
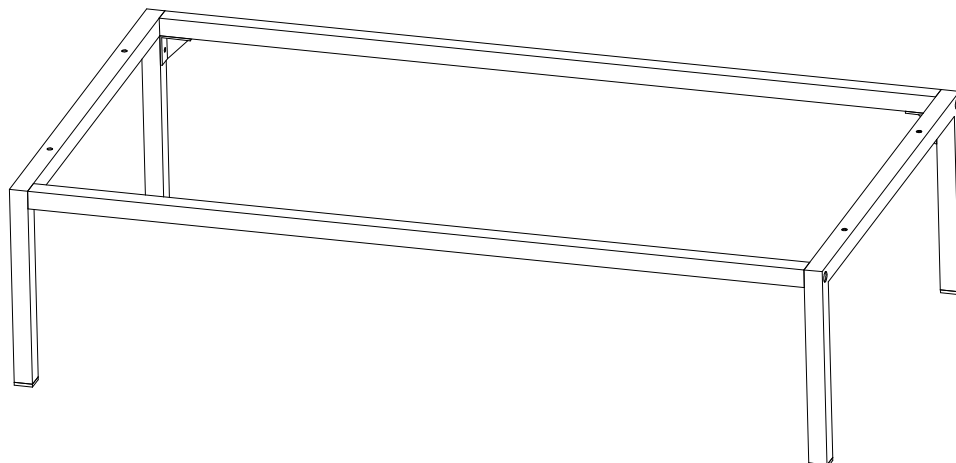

Table accessories

ASPEN 08

		8 x 30 	10x50 	
DP-762	DT-762	K	K1	KM
		15 x 12 		
KORP	KWS	M	PE	PP3
		6 x 34 mm 	4 x 16 	
RB-L-438	RB-R-438	T	W16	W60
				
WKS-15	WS20	Z	ZPH	ZSZ

ST-798



Elements					Accessories	
NR	SYMBOL	LENGTH	WIDTH	QUANTITY	SYMBOL	QUANTITY
1	BL	620	440	1	DP-762	1
2	BP	620	440	1	DT-762	1
3	FT1	397	614	1	K	10
4	FT2	397	614	1	K1	2
5	LC1	768	100	2	KM	4
6	LC2	768	100	1	KORP	4
7	PK	767	429	1	KWS	2
8	WD	768	440	1	M	16
					PE	4
					PP3	4
					RB-L-438	1
					RB-R-438	1
					T	16
					W16	22
					W60	2
					WKS-15	4
					WS20	4
					Z	16
					ZPH	4
					ZSZ	4

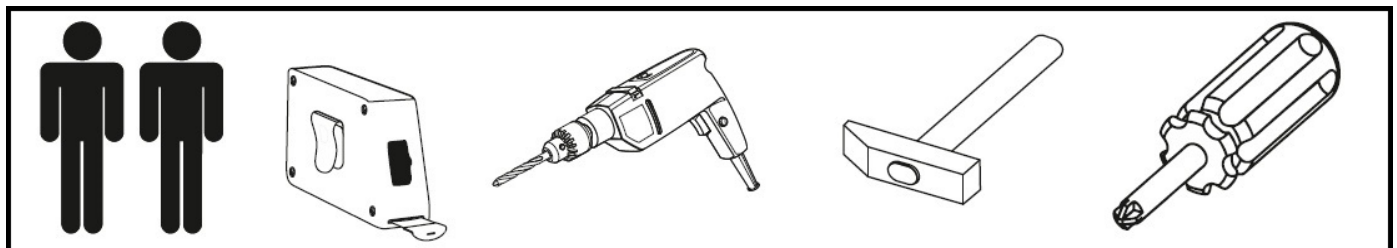

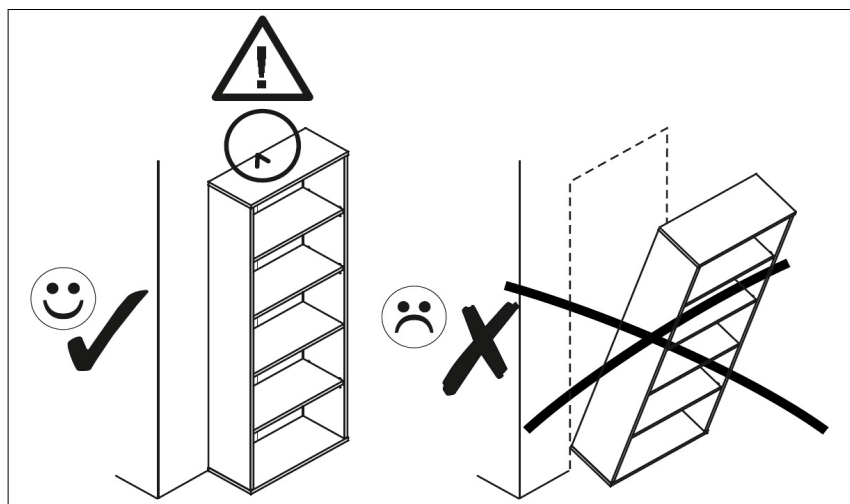

<p>PL UWAGA! Mebel trzeba trwale zamocować do ściany, aby uniknąć przewrócenia się mebla. W paczce są akcesoria przystosowane wyłącznie do ścian betonowych i z pełnej cegły. Jeśli nie jesteś pewien co do budowy ściany, skonsultuj się ze specjalistą.</p>	<p>EN ATTENTION! The furniture must be permanently attach to the wall, to avoid falling over furniture. There are accessories in the package adapted only to the walls concrete and solid brick. If you are not sure about the constructionwalls, consult expert.</p>	<p>D ACHTUNG! Die Möbel müssen dauerhaft seinan der Wand befestigen,um nicht umzufallen Möbel. Es gibt Zubehör in der Verpackung nur an die Wände angepasst Beton und Vollziegel. wenn Sie sind sich nicht sicher über die Konstruktion Wände konsultieren Spezialist.</p>
<p>IT NOTA! I mobili devono essere permanenti attaccare al muro, per evitare di cadere mobili. Ci sono accessori nel pacchetto adattato solo alle pareti mattone concreto e solido. se non sei sicuro della costruzione muri, consultare specialista.</p>	<p>SLO POZOR! Kus musí byť natrvalo pripojit' k stene, aby sa zabránilo pádu nábytok. Sú v balení príslušenstvo prispôsobené len pre steny betón a pevné tehly. ak Nie ste si istý stavbou konzultujte s odborníkom.</p>	<p>ES NOTA! La pieza necesita ser permanentemente pegar a la pared, para evitar caerse muebles. Estan en el paquete accesorios adaptados solo para paredes Hormigón y ladrillo macizo. si no estás seguro de la construcción Paredes, consultar a un especialista.</p>
<p>FR REMARQUE! La pièce doit être en permanence attacher au mur, pour éviter de tomber meubles. Ils sont dans le paquet accessoires adaptés seulement pour les murs béton et brique pleine. si vous n'êtes pas sûr de la construction murs, consultez un spécialiste.</p>	<p>CZ POZOR! Kus musí být natrvalo připevnit ke zdi, aby se zabránilo pádu nábytek. Jsou v balení příslušenství přizpůsobené pouze pro stěny betonové a pevné cihly. pokud Nejste si jisti stavbou konzultovat odborníka.</p>	

1.

1.



2.

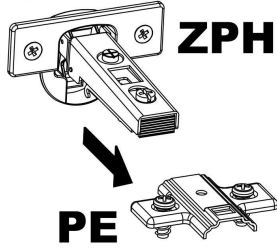

OPTIONAL PP3

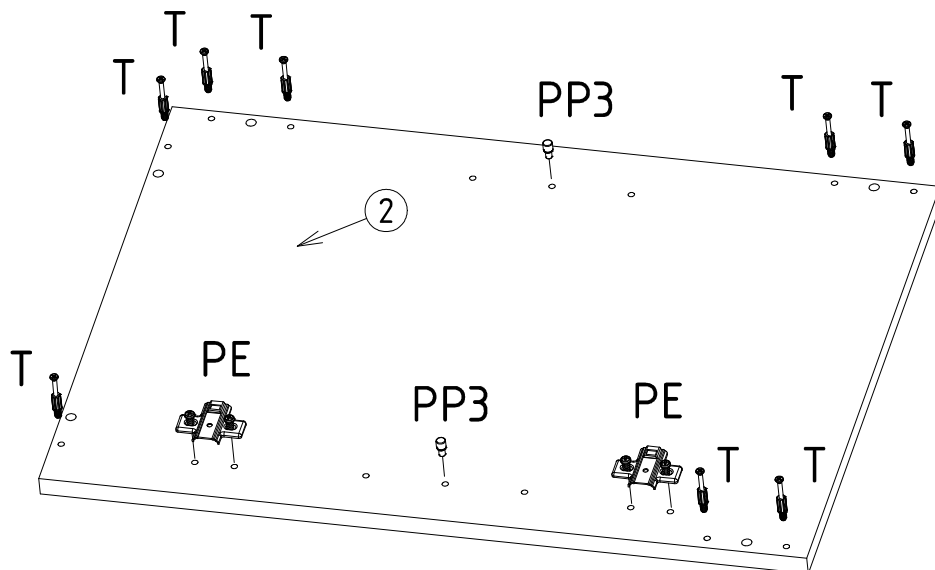
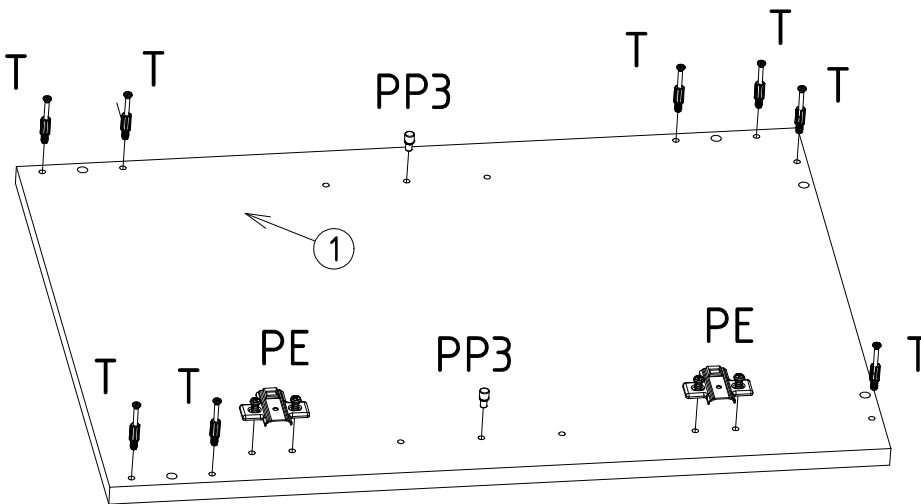
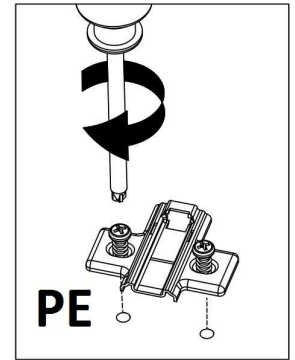
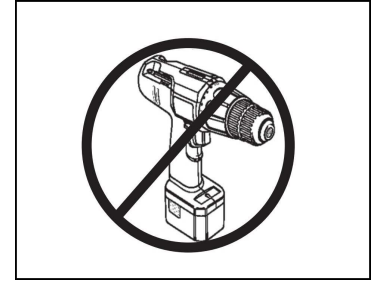
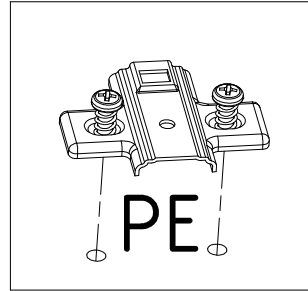
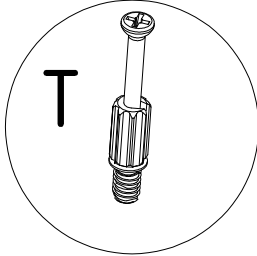
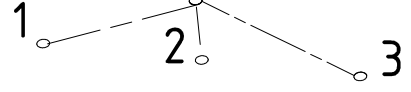

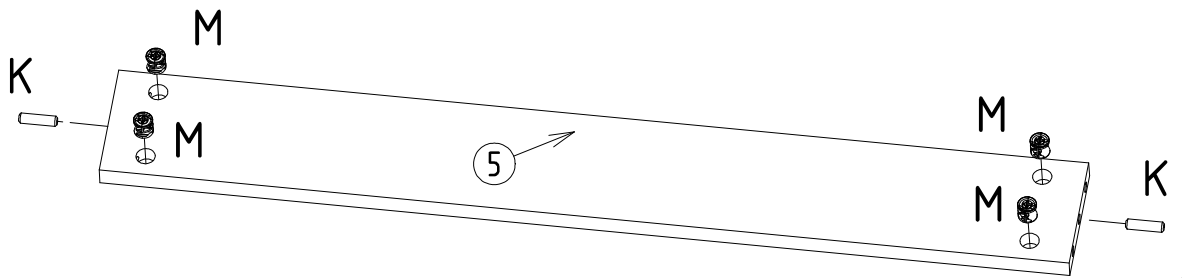
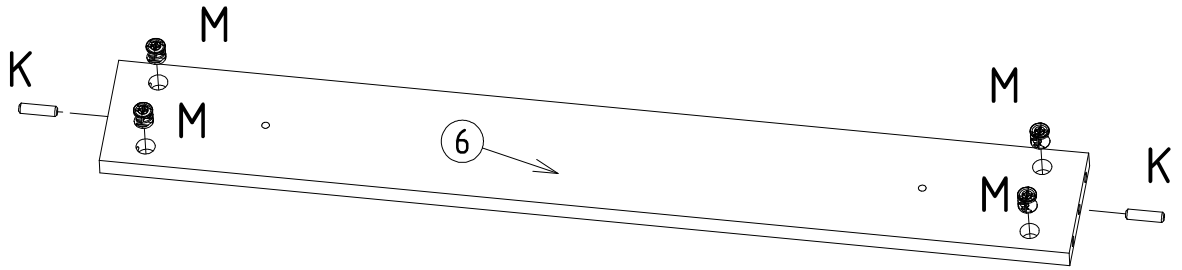
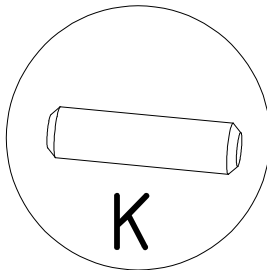
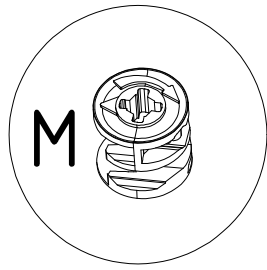

x2

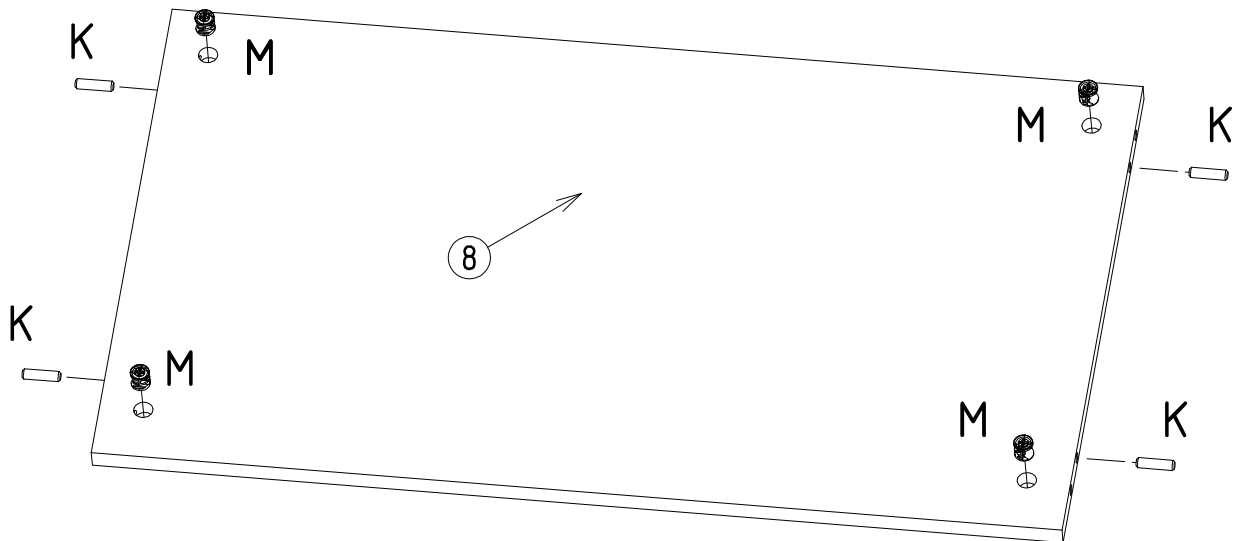

2.

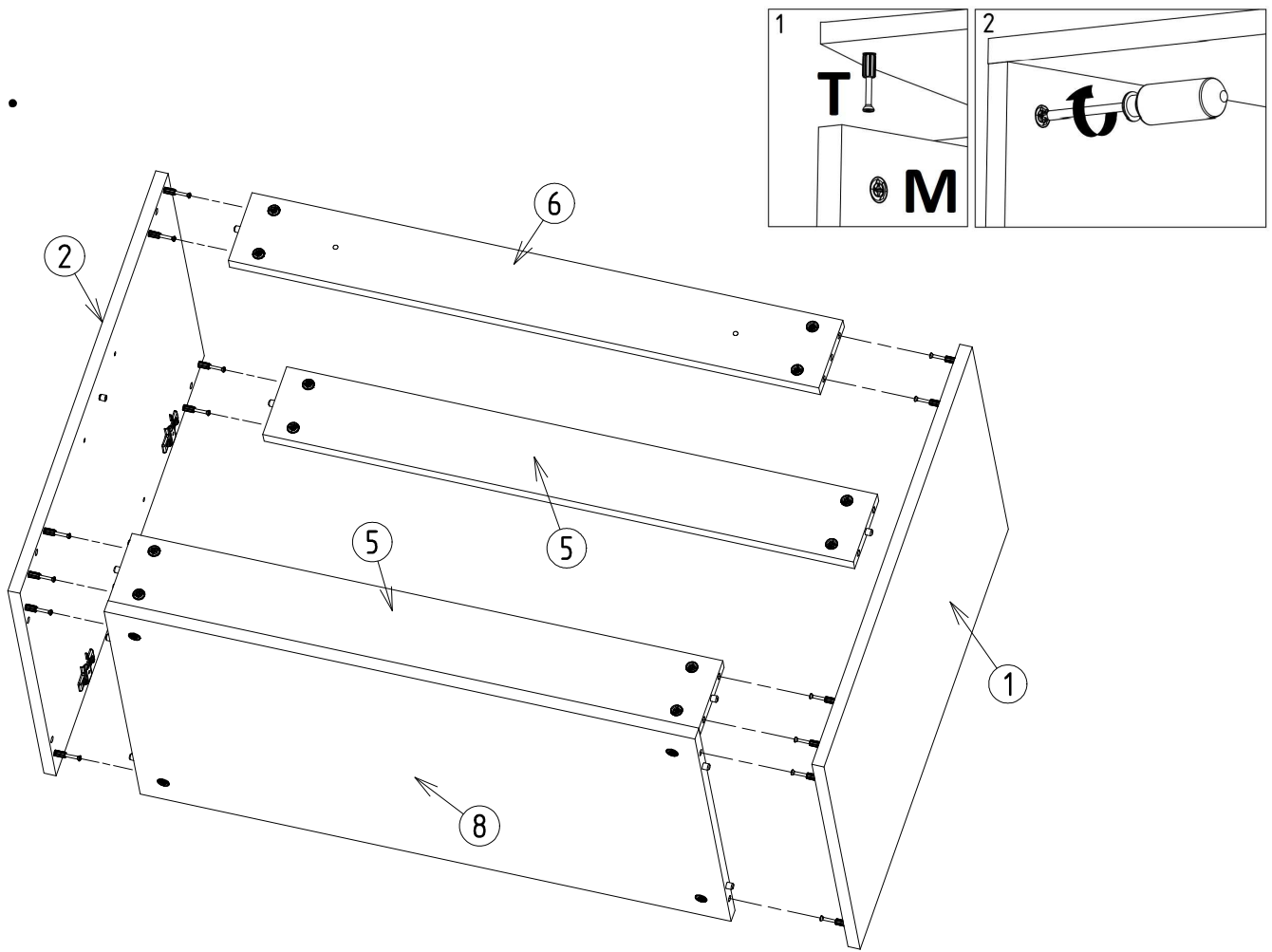

3.

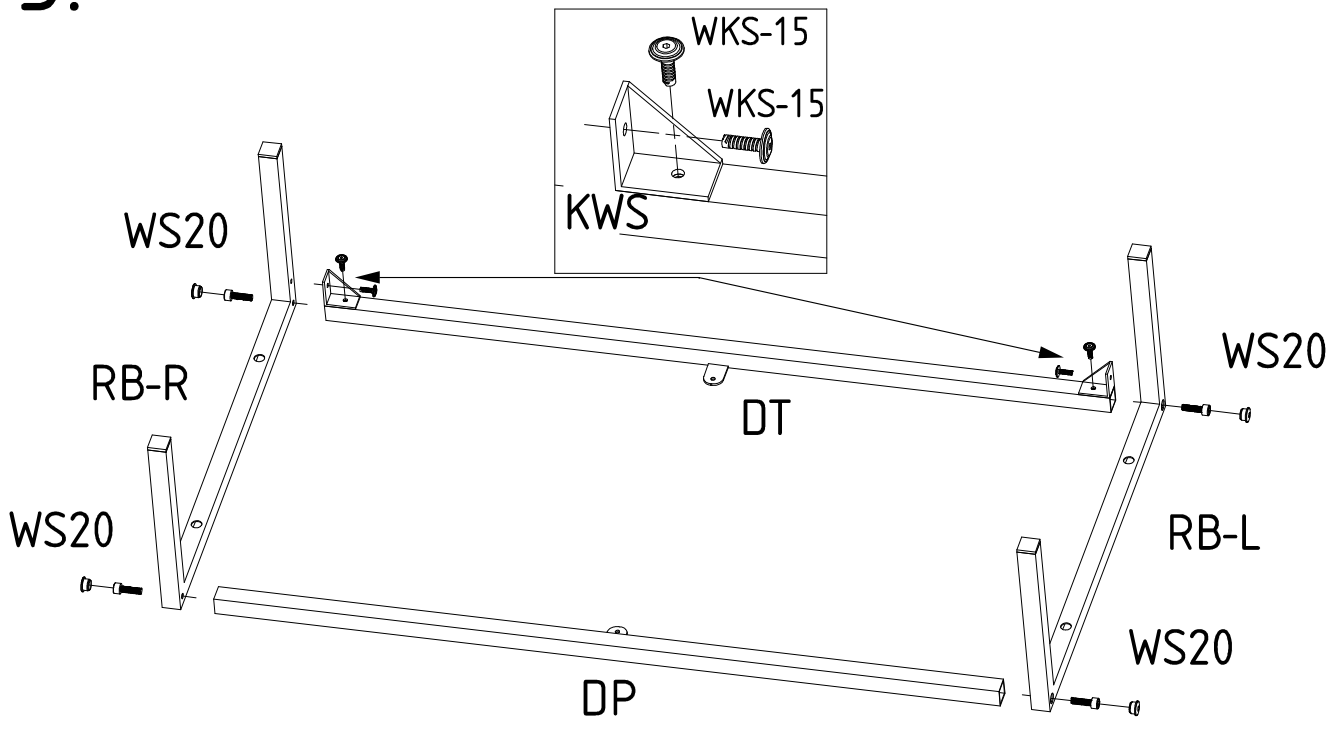

4.

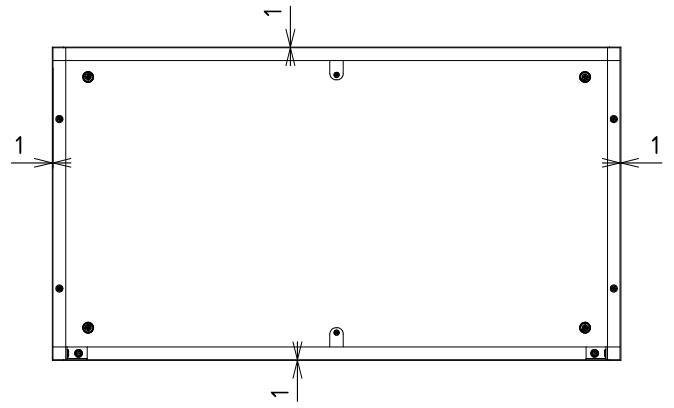
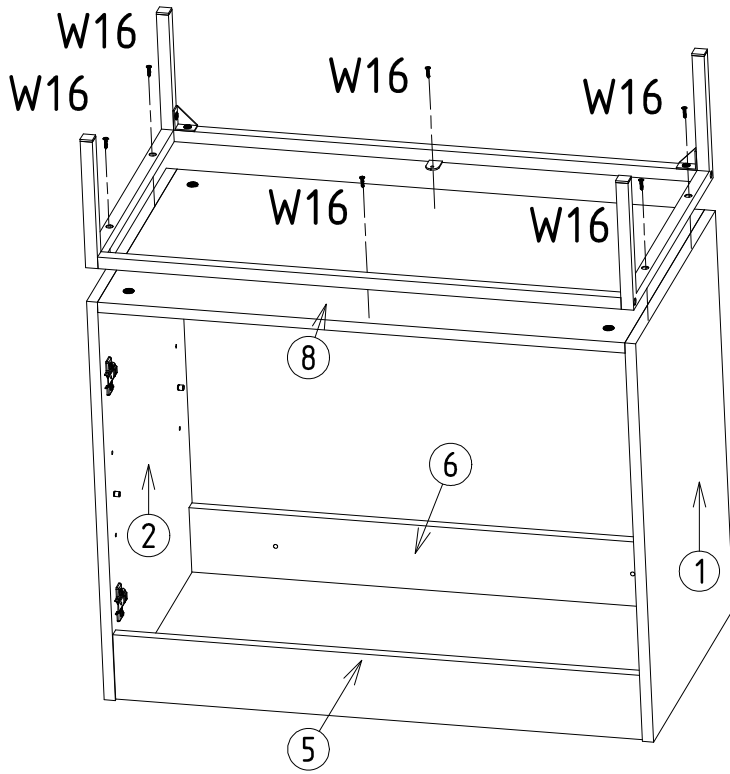

5.

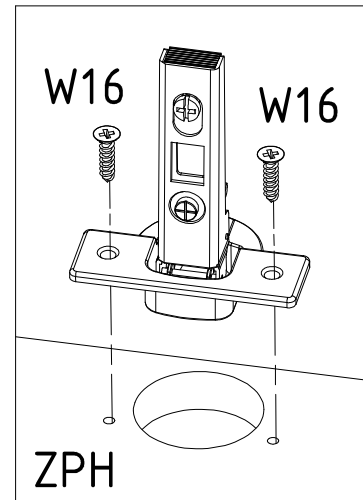
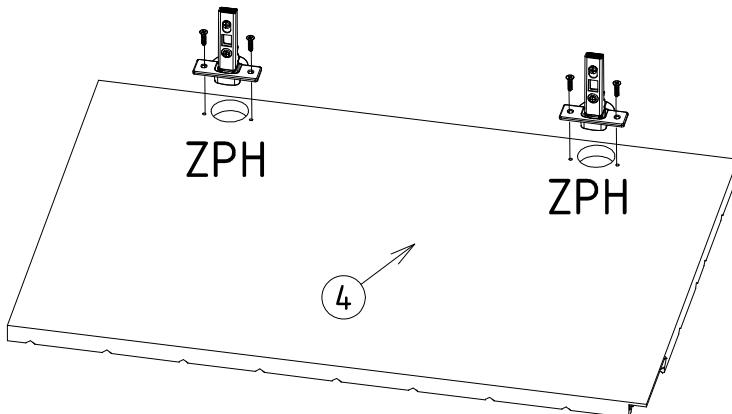
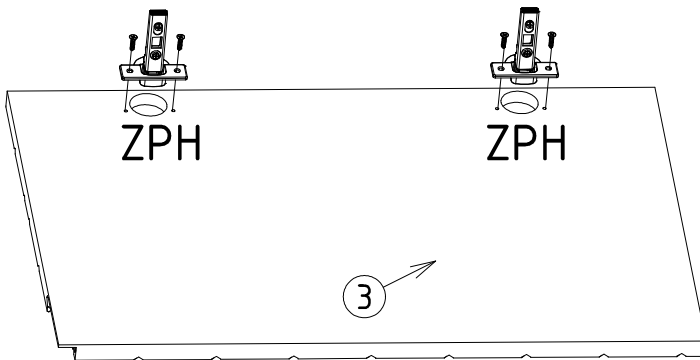

6.

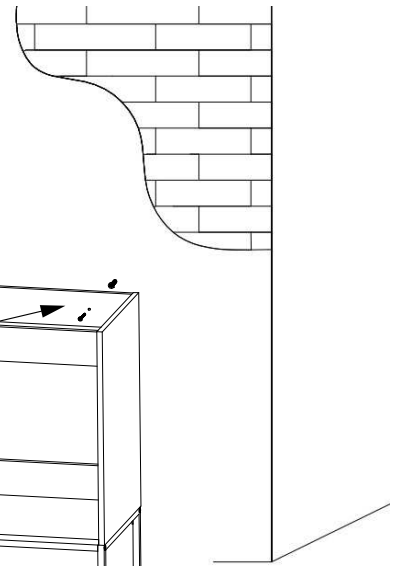
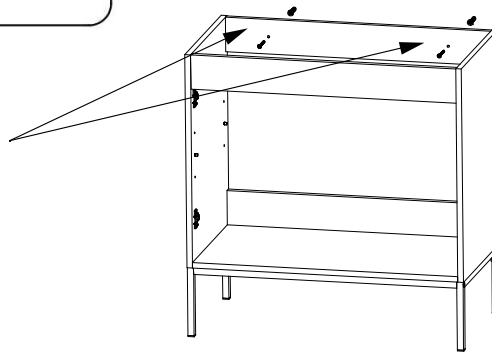
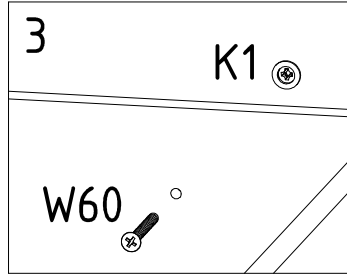
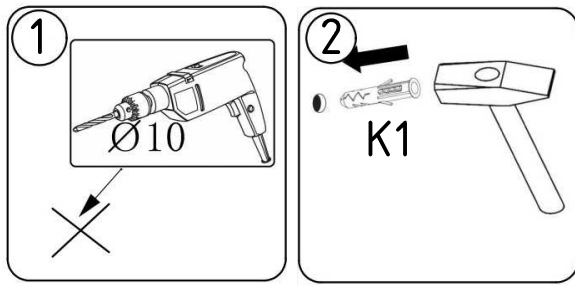

7.

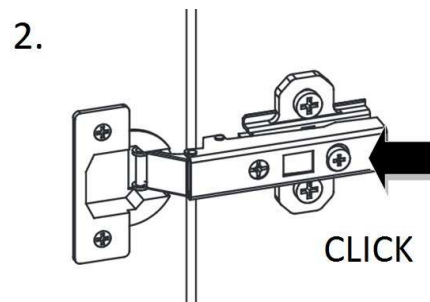
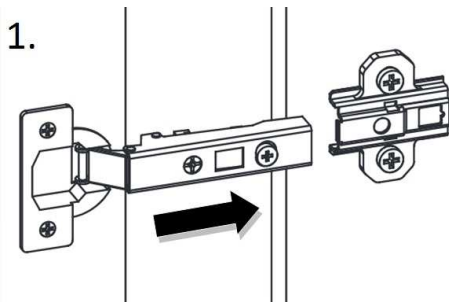
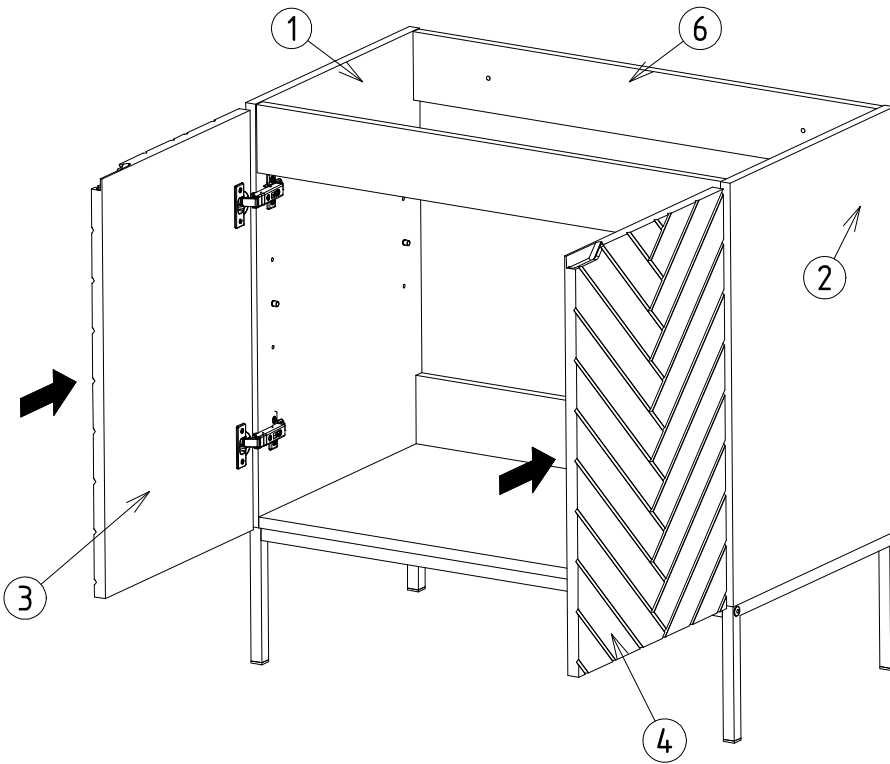

8.

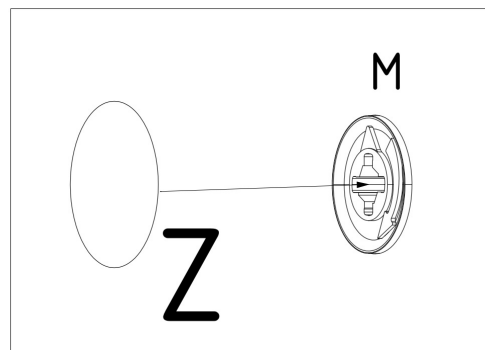
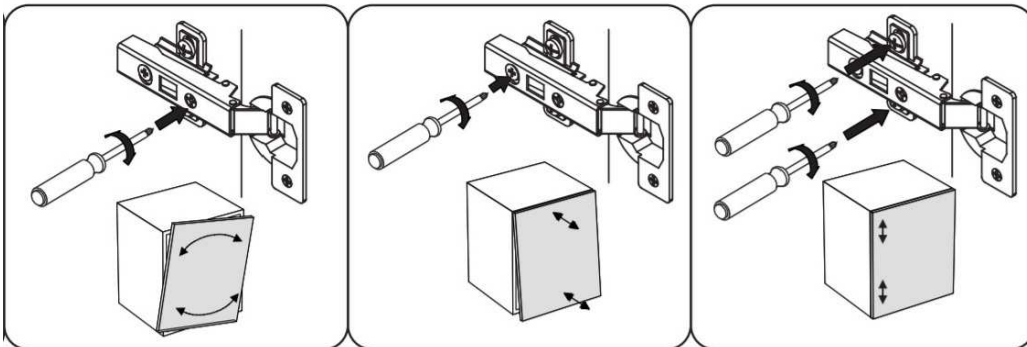
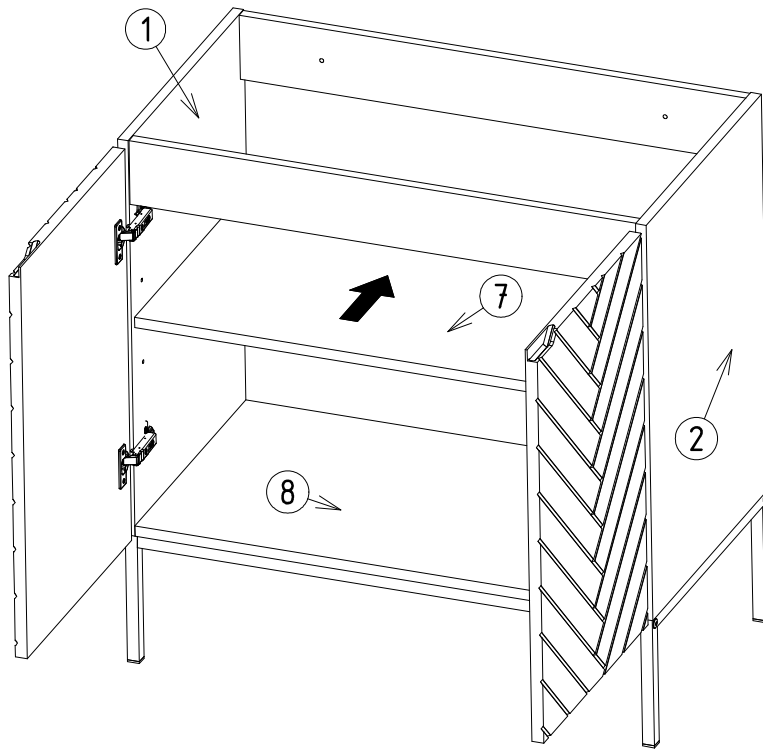

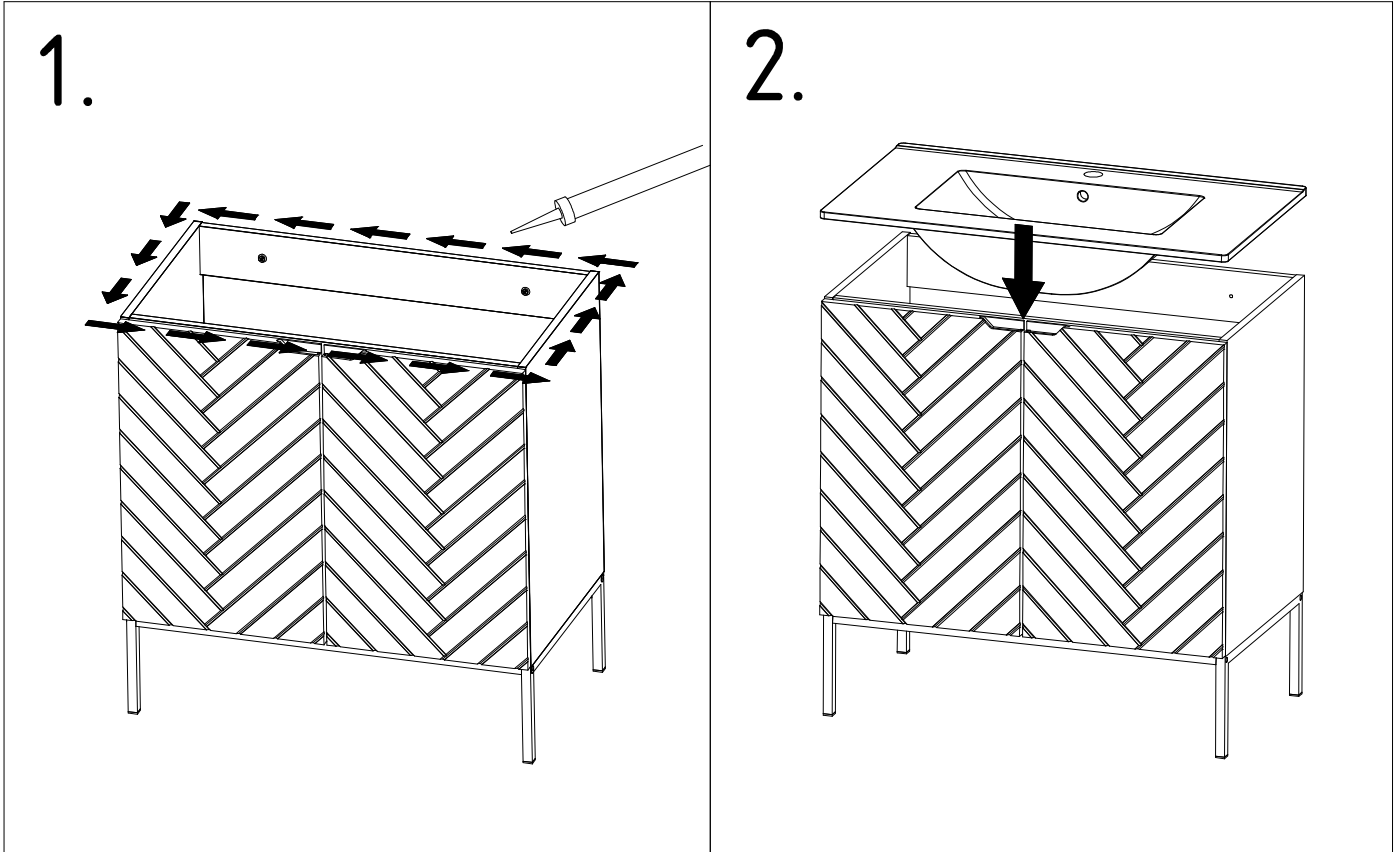
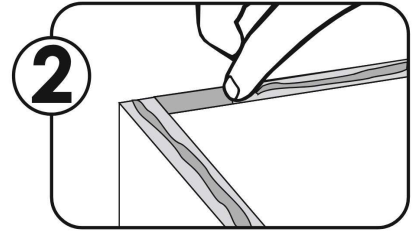
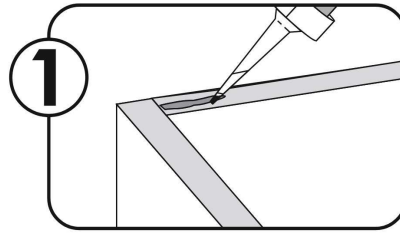
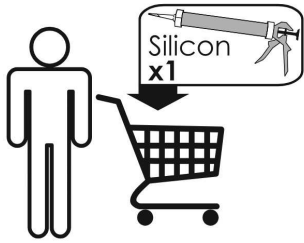

2.

