

ASPEN

ASPEN-05

OP-310

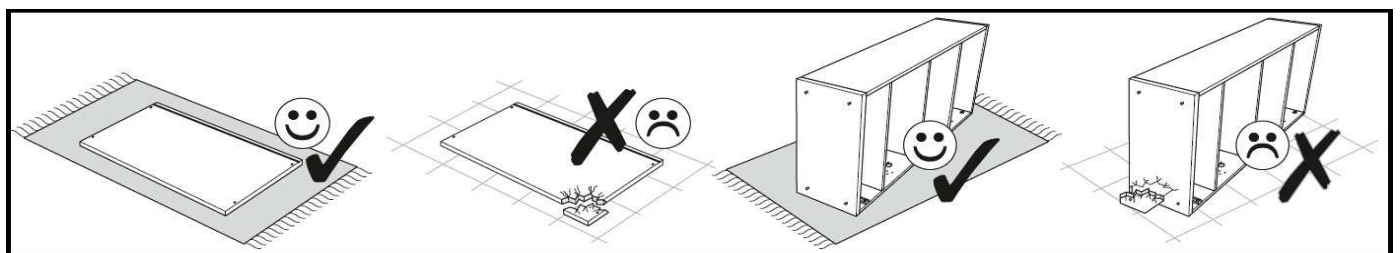
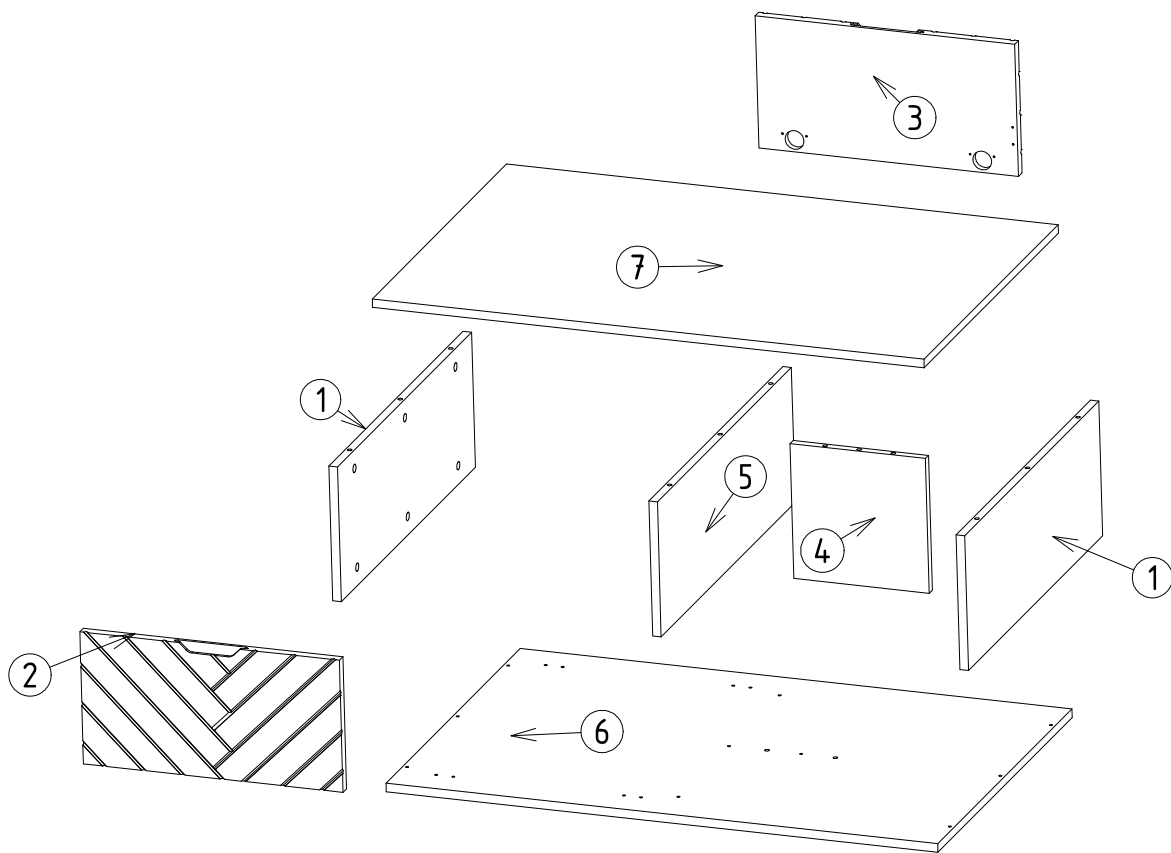
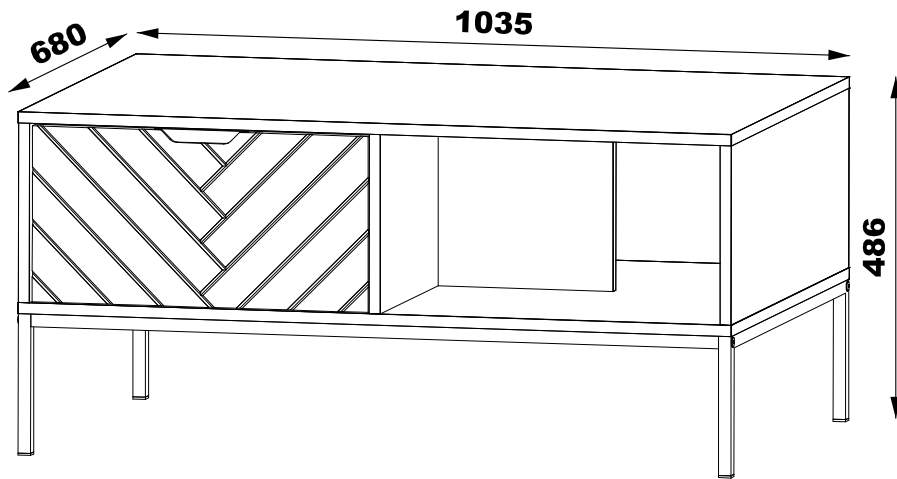
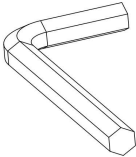

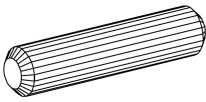

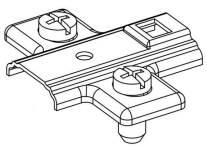
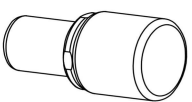

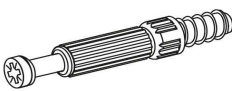

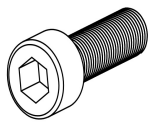
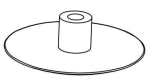
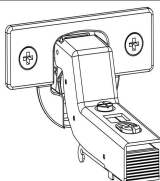

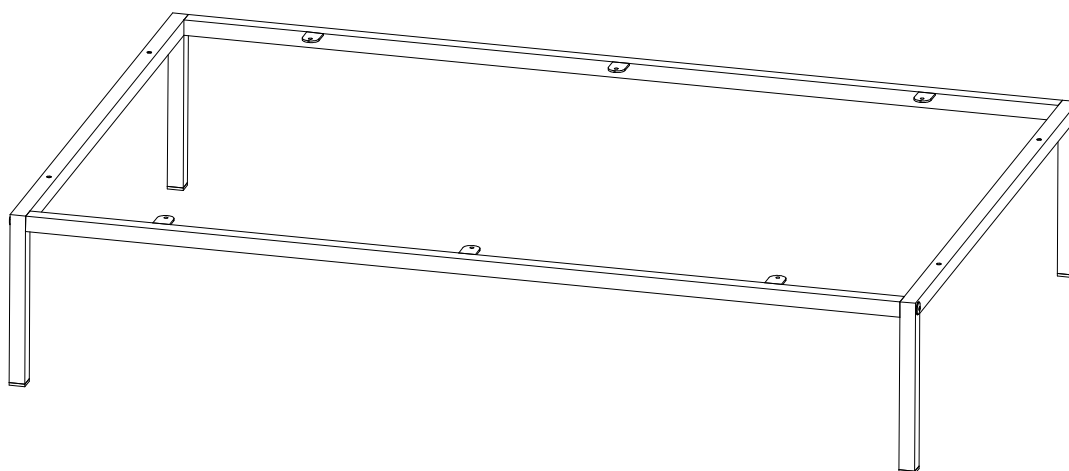

Table accessories

ASPEN 05

 <p>A2</p>	 <p>DP-998</p>	<p>8 x 30</p>  <p>K</p>	 <p>KORP</p>	<p>15 x 12</p>  <p>M</p>
 <p>PE</p>	 <p>PP3</p>	 <p>RB-679</p>	<p>60N</p>  <p>SB</p>	<p>6 x 34 mm</p>  <p>T</p>
<p>4 x 16</p>  <p>W16</p>	 <p>WS20</p>	 <p>Z</p>	 <p>ZPWH</p>	 <p>ZSZ</p>

ST-1034



Elements					Accessories	
NR	SYMBOL	LENGTH	WIDTH	QUANTITY	SYMBOL	QUANTITY
1	BK	679	254	2	A2	1
2	FT1	487	249	1	DP-998	2
3	FT2	487	249	1	K	4
4	PB	254	254	1	KORP	4
5	PPIO	679	254	1	M	20
6	WD	1035	680	1	PE	4
7	WG	1035	680	1	PP3	2
					RB-679	2
					SB-60	2
					T	20
					W16	24
					WS20	4
					Z	20
					ZPWH	4
					ZSZ	4

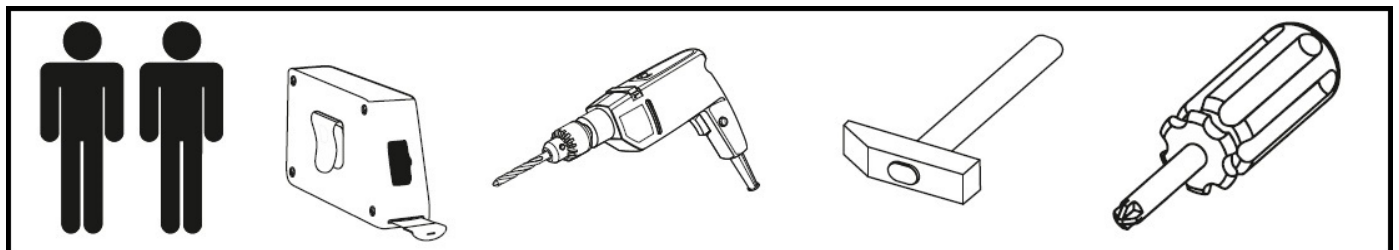

1.

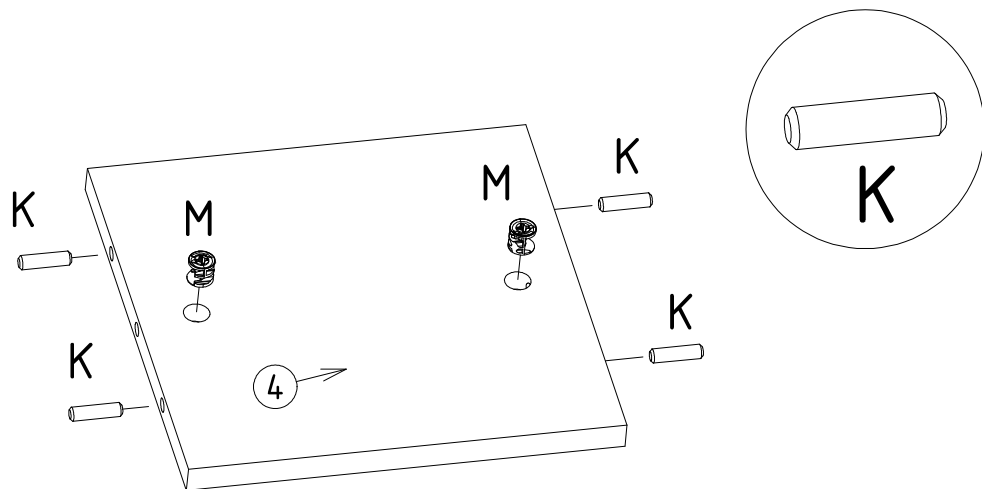
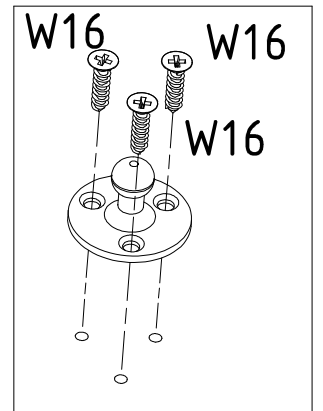
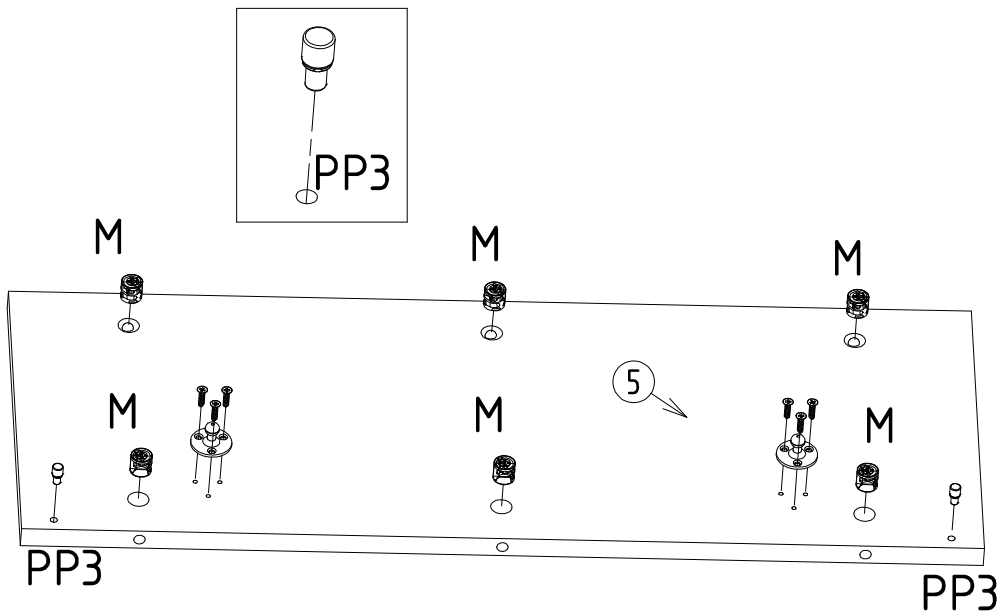
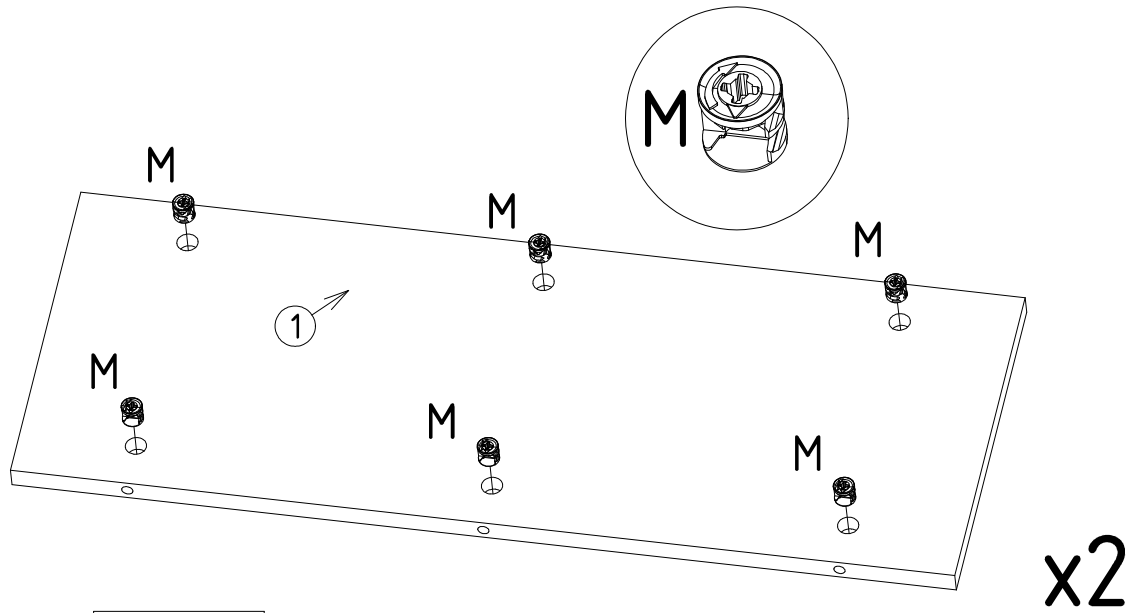

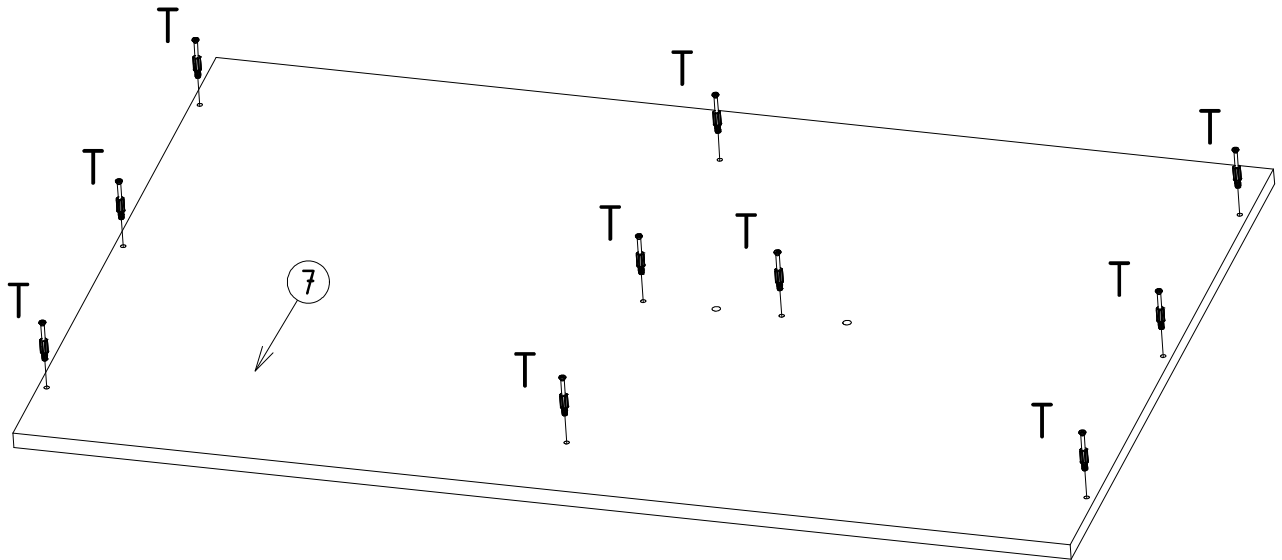
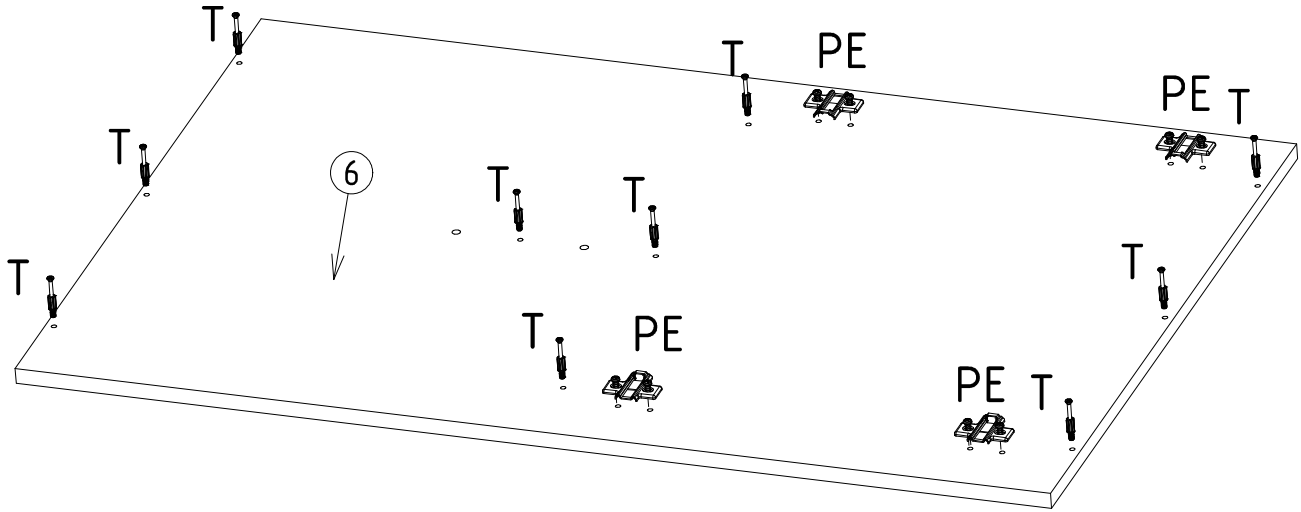
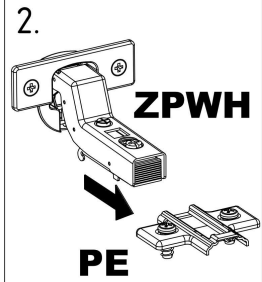
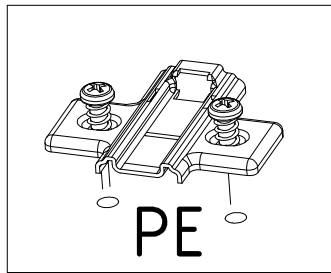
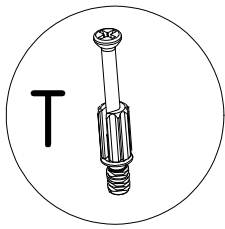

2.

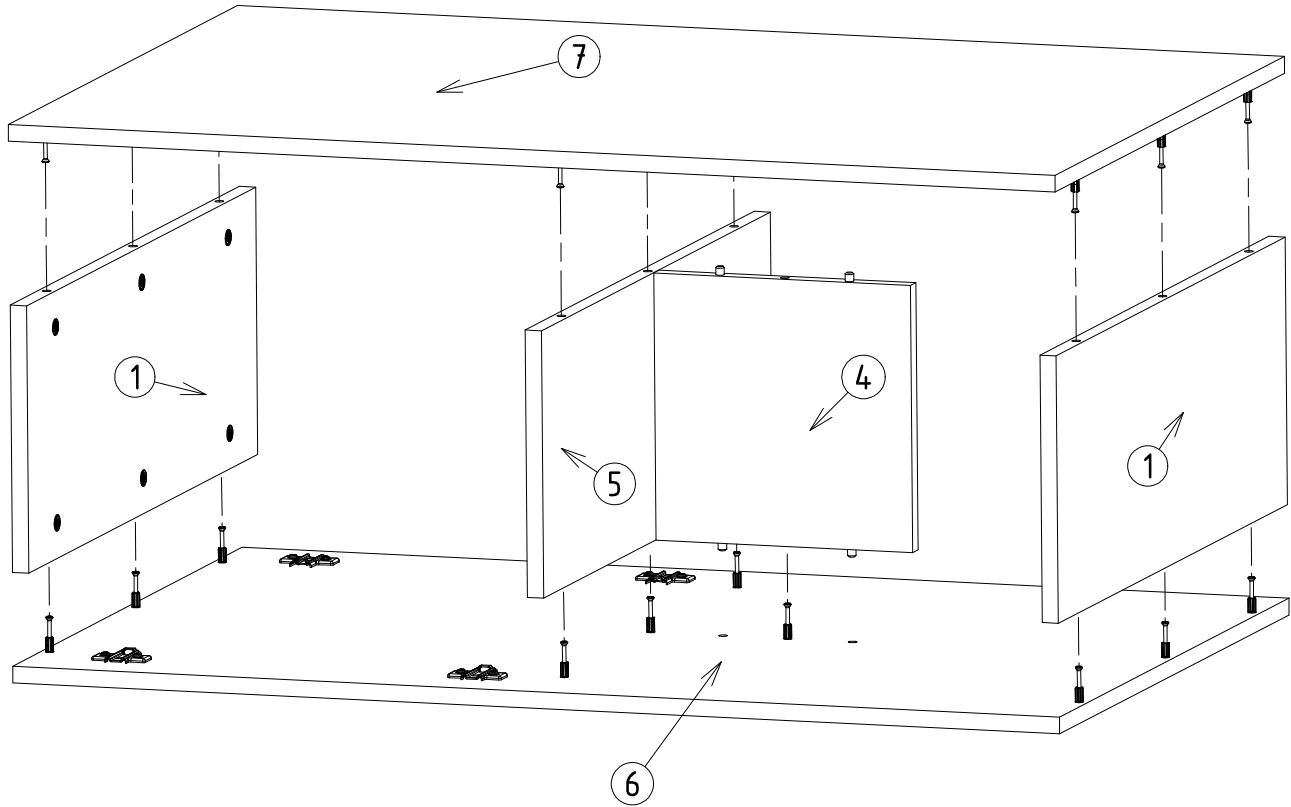
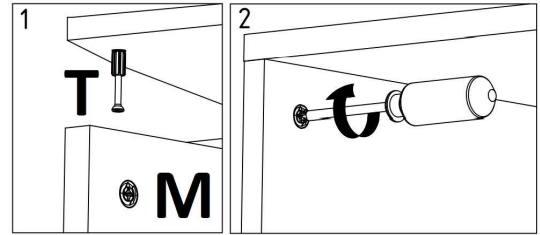

3.

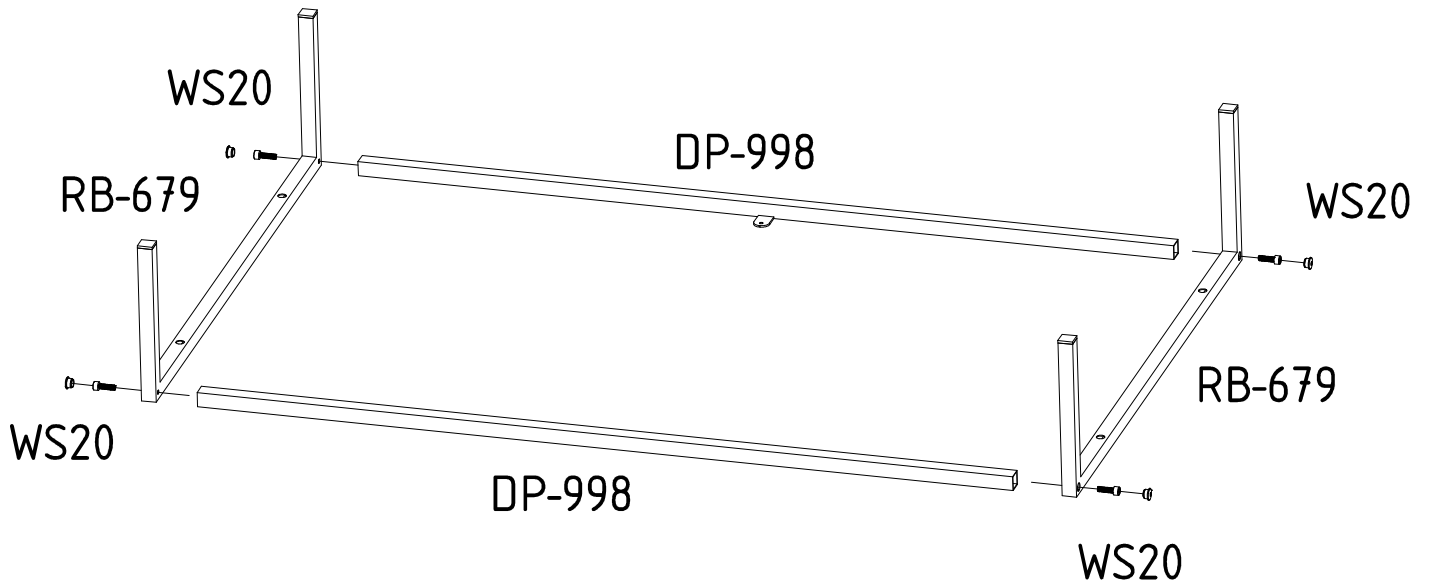

4.

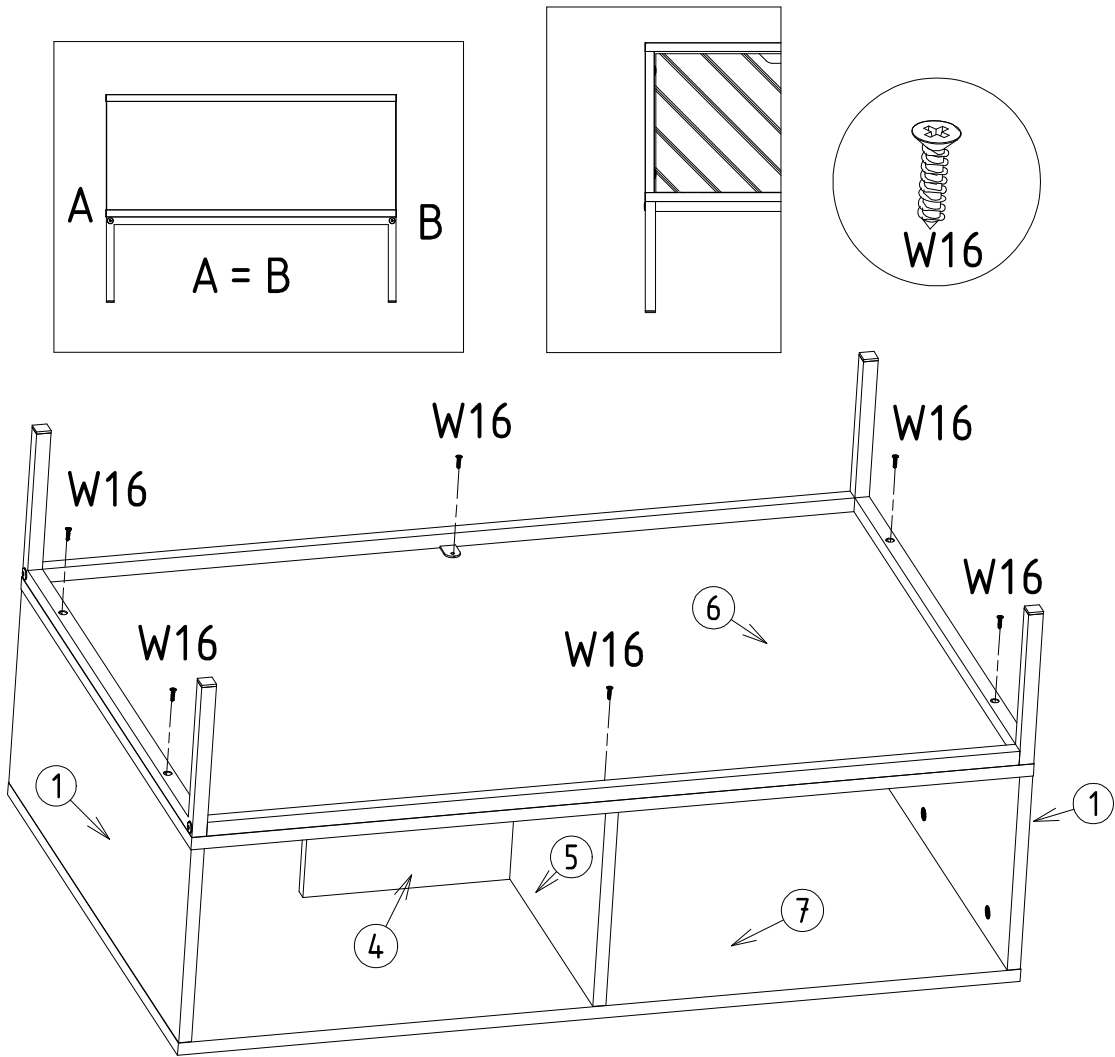

5.

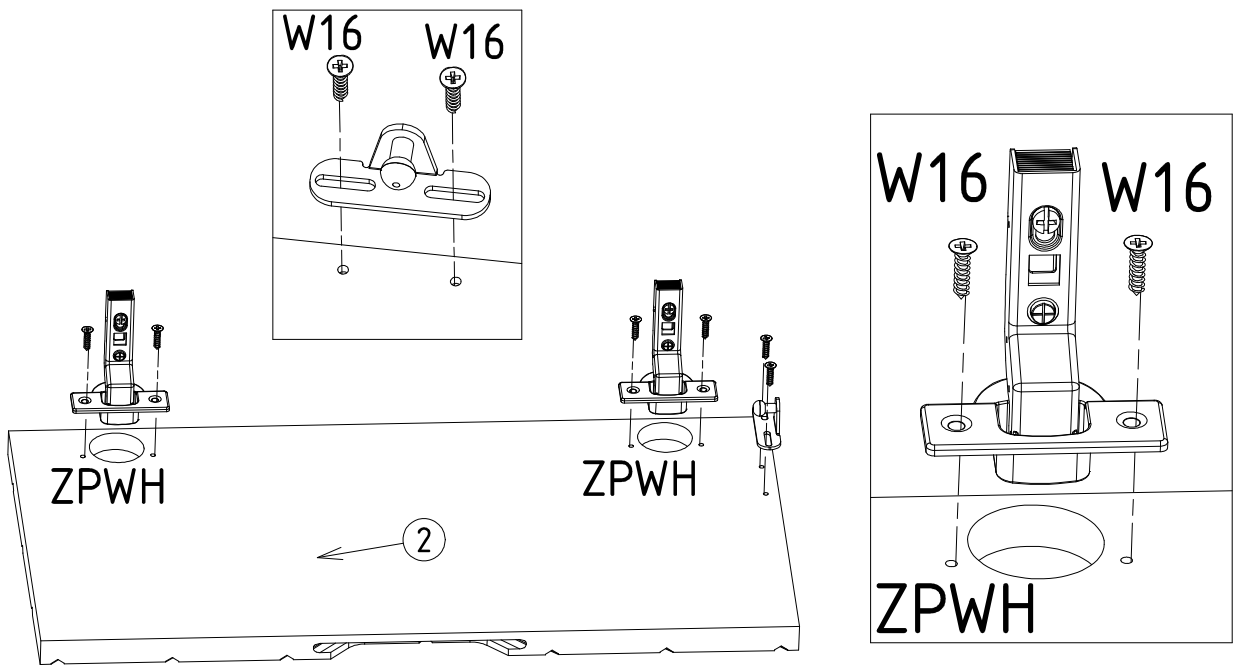

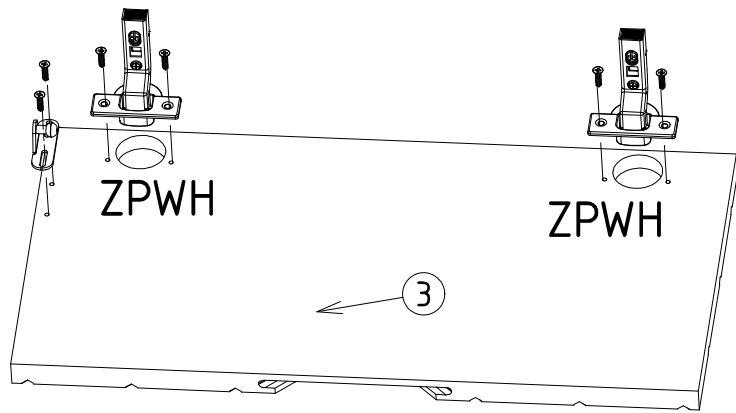

6.

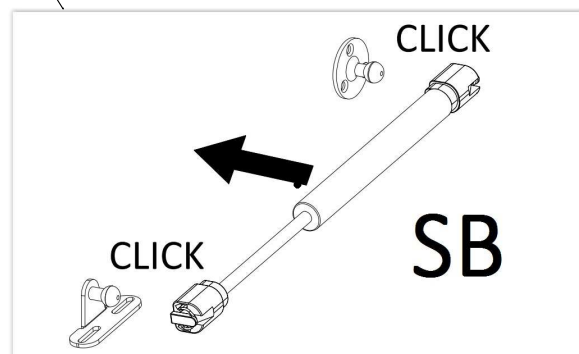
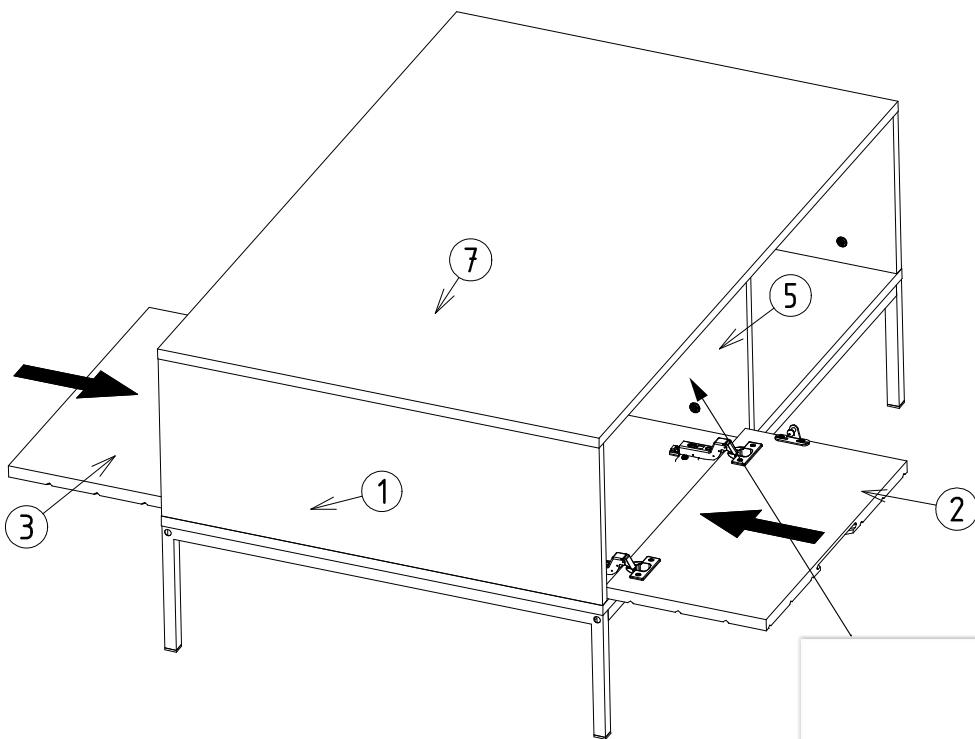
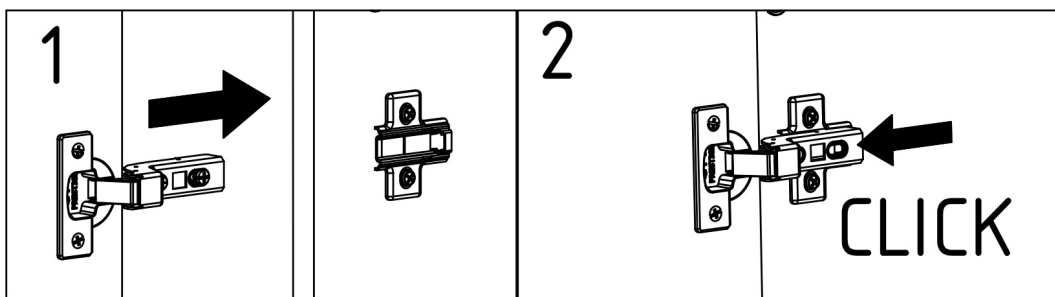

7.

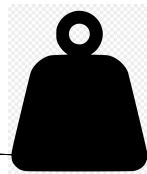
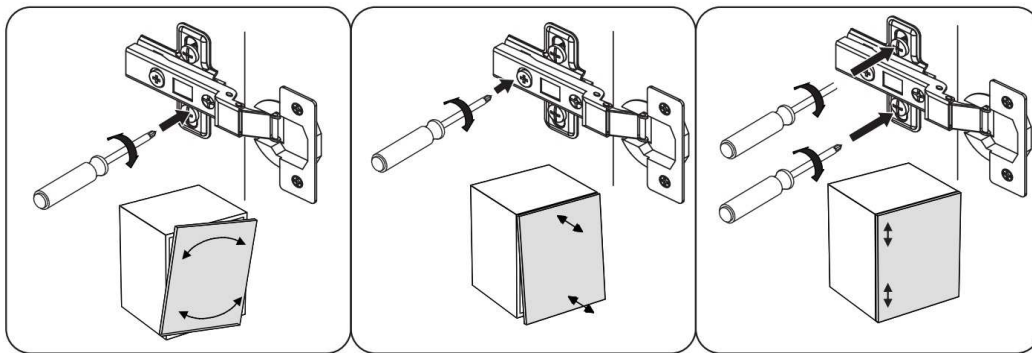

max.
10 kg

