







ASSEMBLY INSTRUCTION

ITEM NO. : AM-0889-1

KEY	QTY	DESCRIPTION	KEY	QTY	DESCRIPTION
A	1		D	1	 M6*25mm
B	2		E	4	 M6*45mm
C	5		F	1	

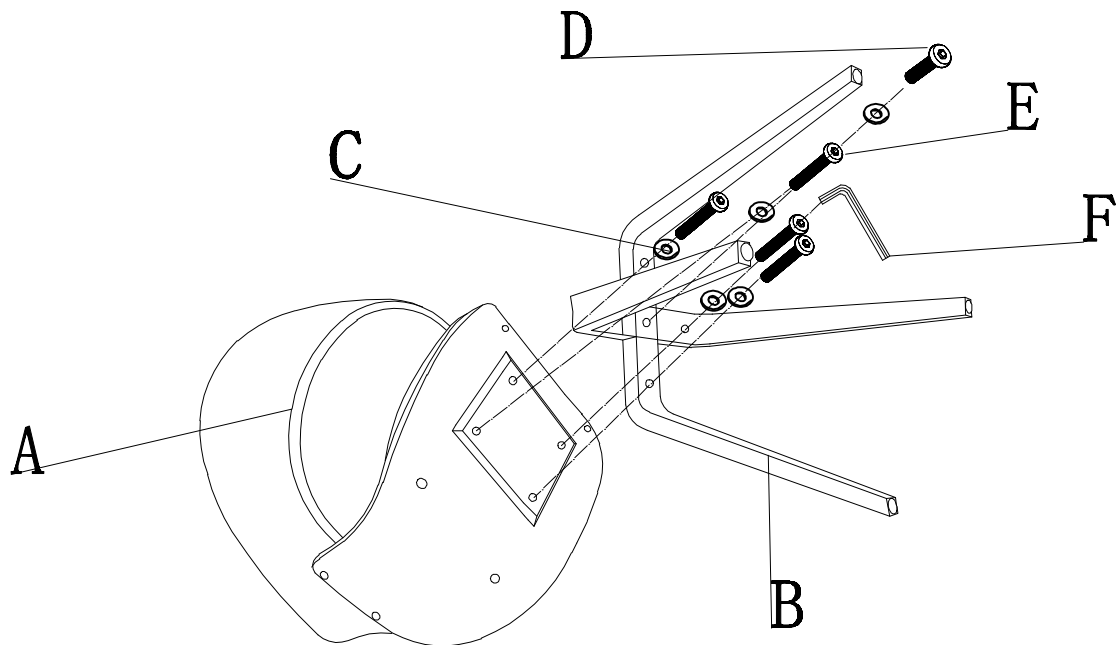

STEP 1



STEP 2