

.mdd

# K3104

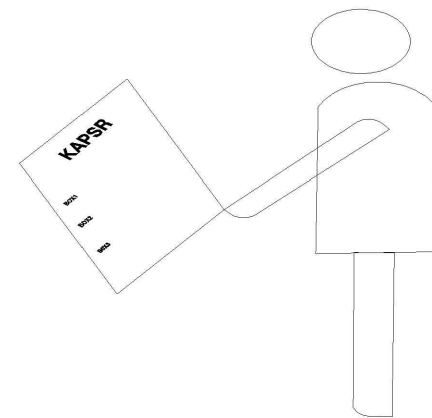

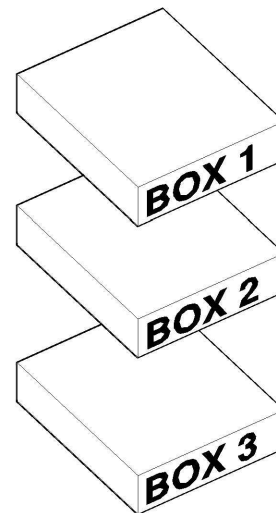
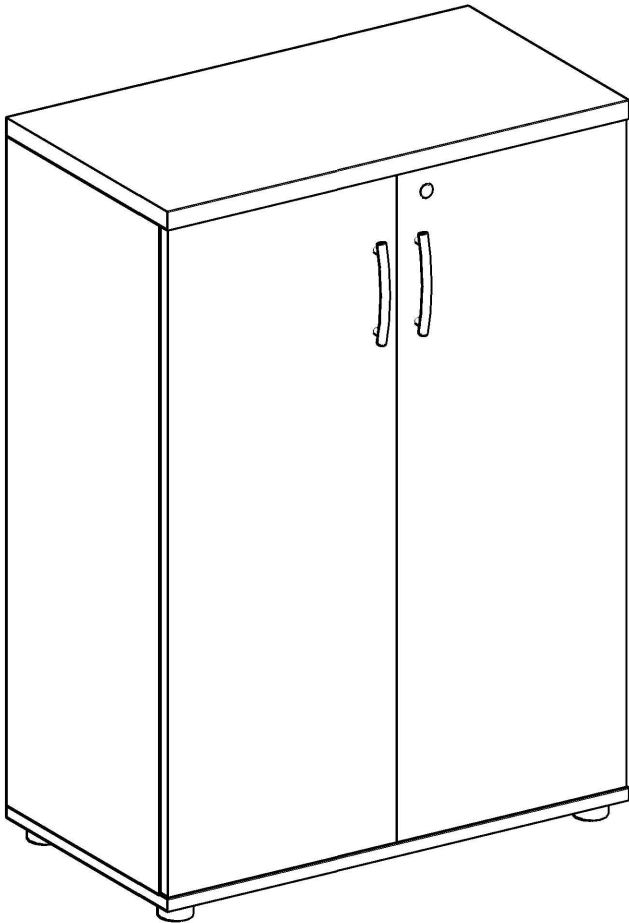
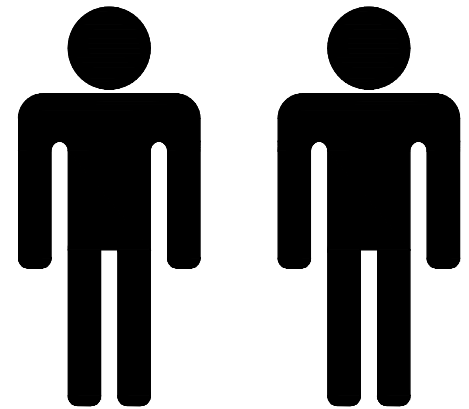
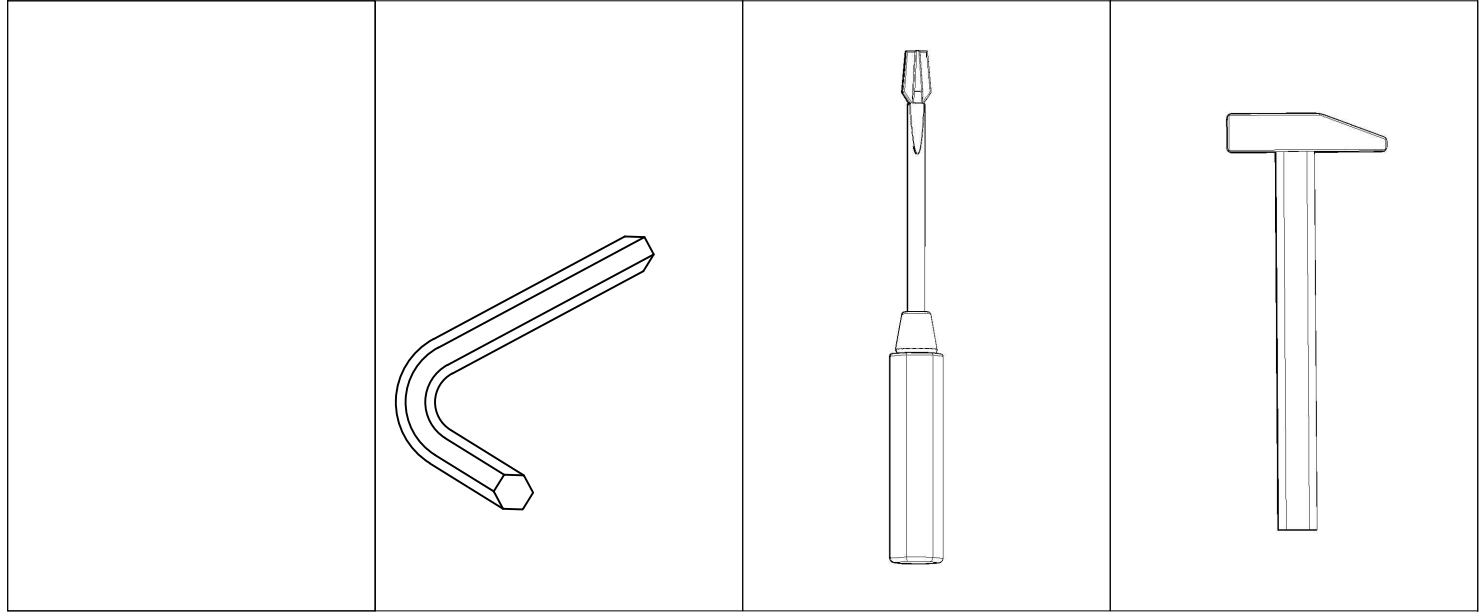
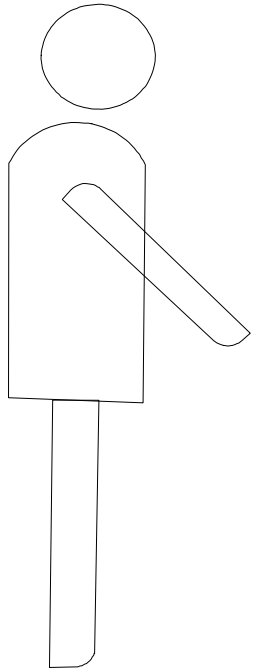

2

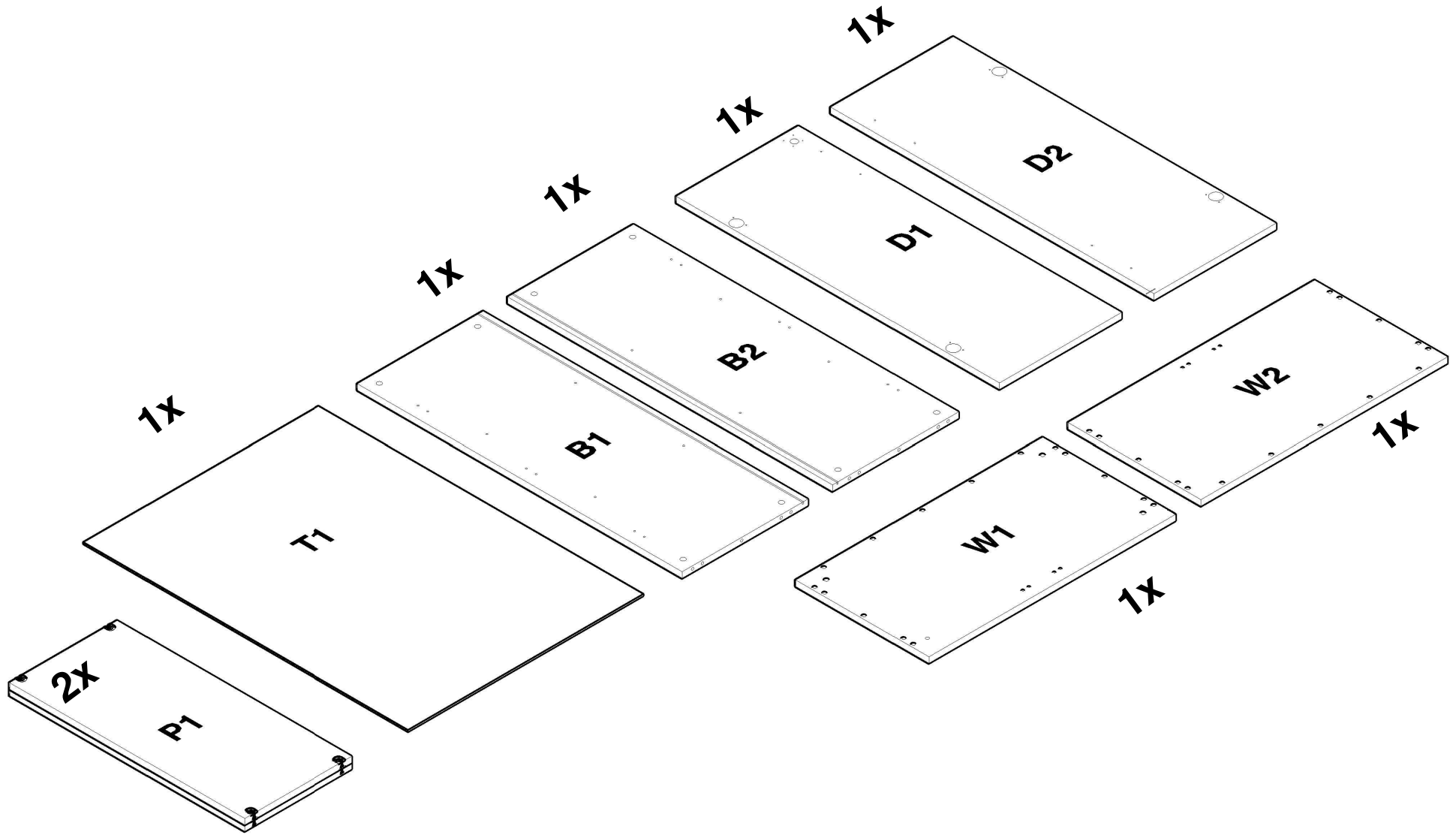

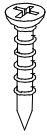

4x

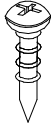

6x

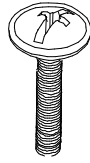

2x

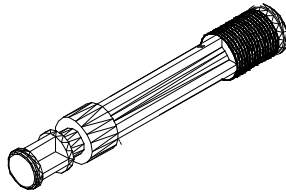

8x

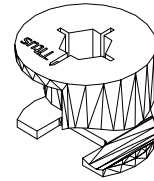

8x

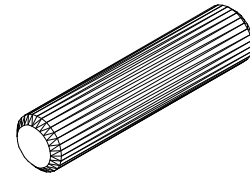

8x



8x

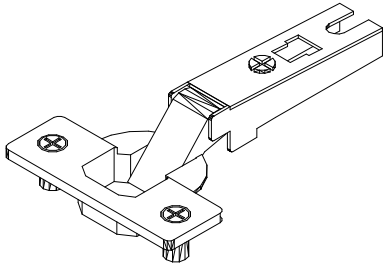

4x

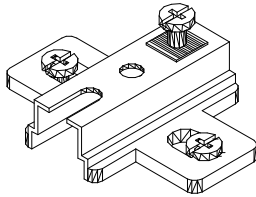

4x

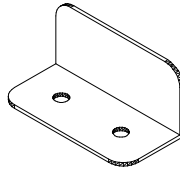

3x

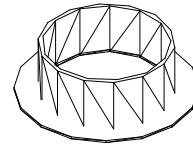

1x

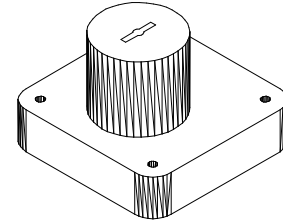

1x

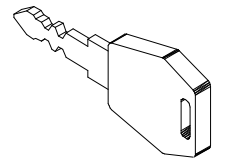

2x

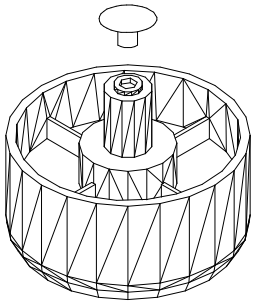

4x

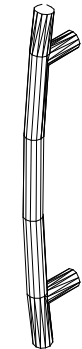

2x

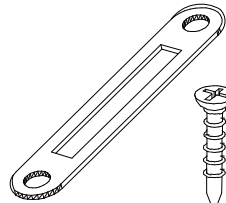

1x

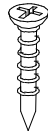

2x

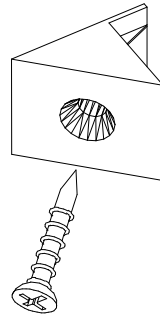

8x

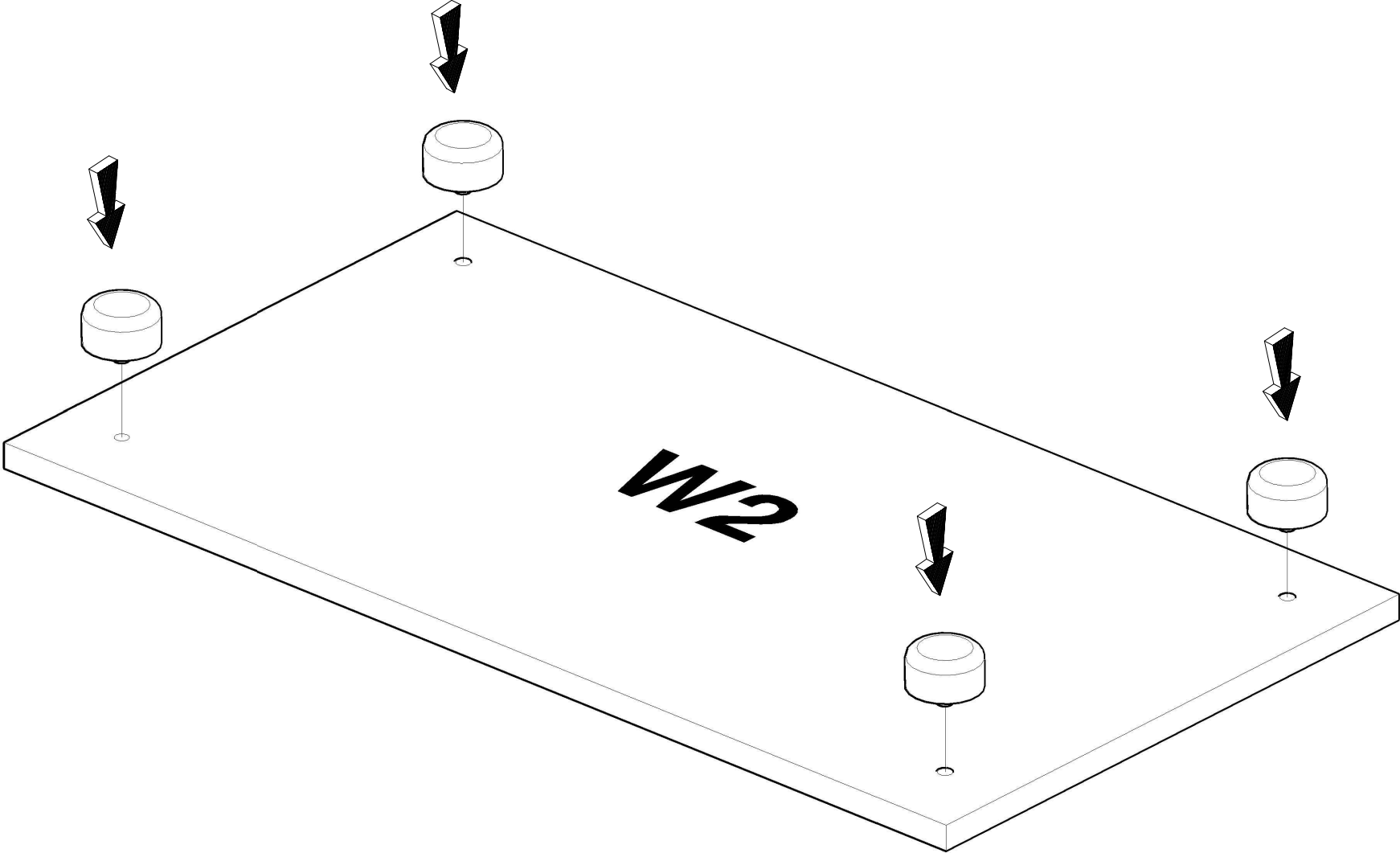

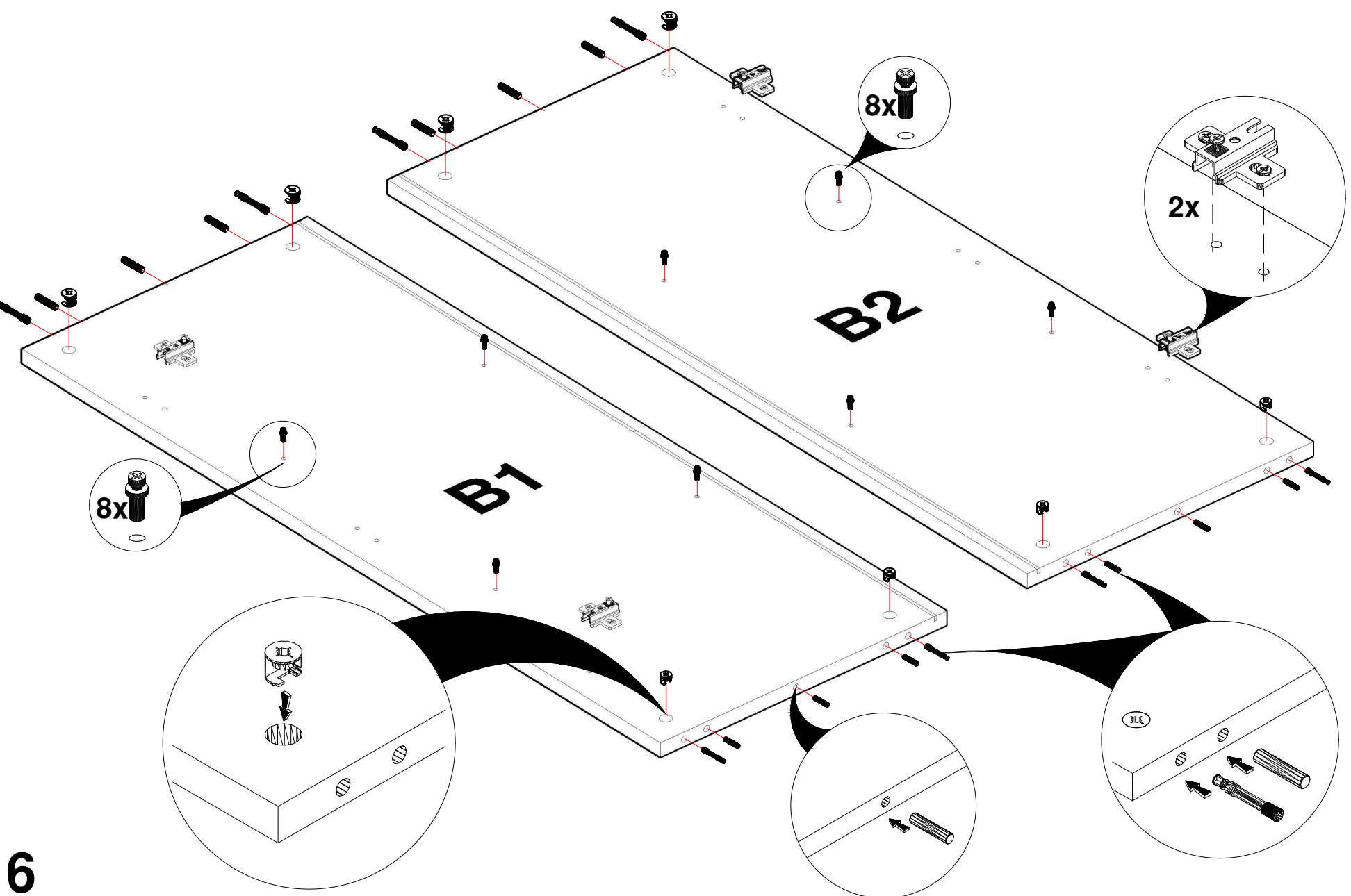

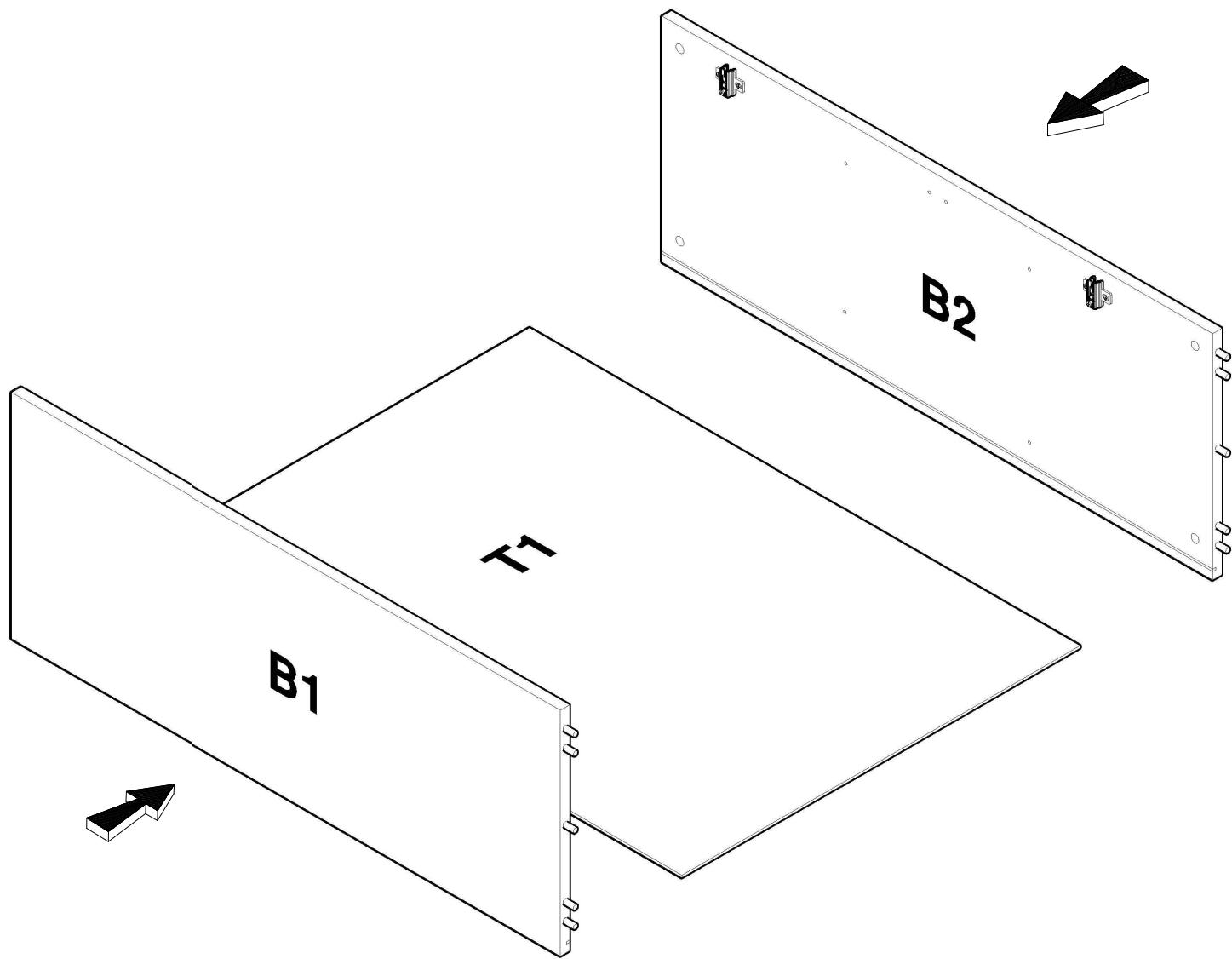

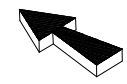
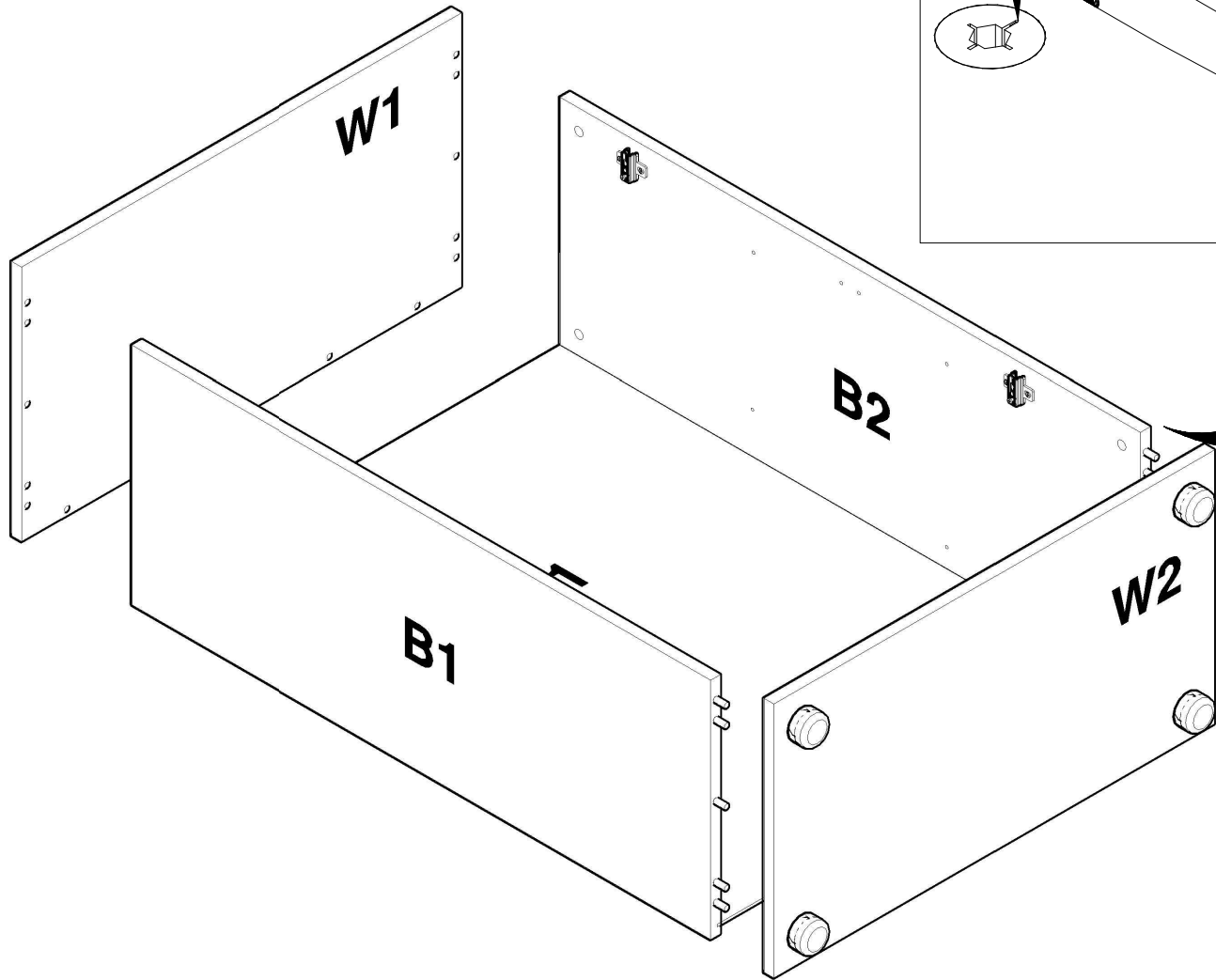
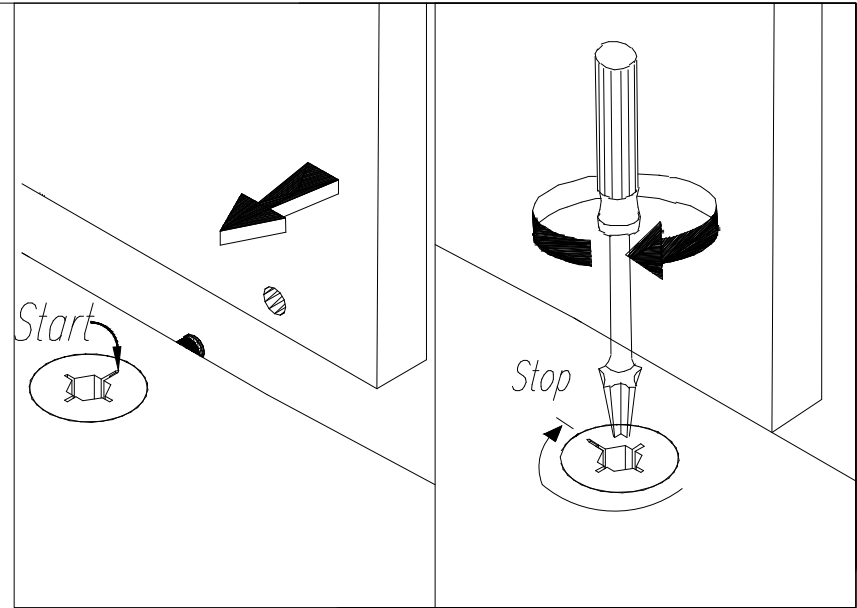
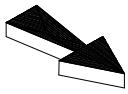



10

