

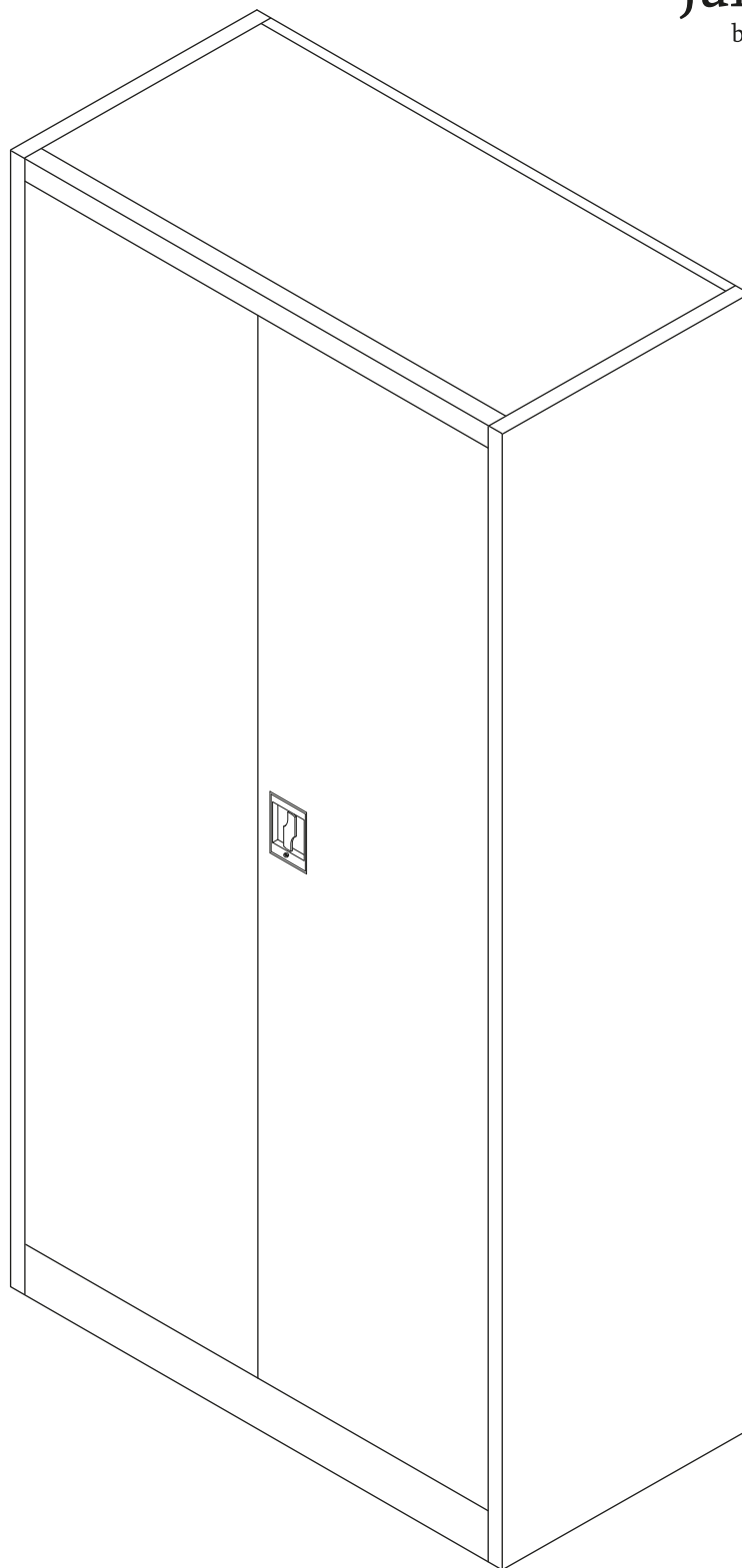

Jan Nowak

by DOMATOR 24



[/domator24/videos](https://www.youtube.com/channel/UCdomator24)

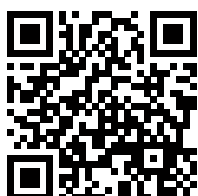

MODEL:
JAN



ENGLISH

WARNING

Furniture falling over might cause serious damage or even death. To avoid it, furniture must be placed on a levelled surface.

Pay attention to glazed elements of the cabinet. If you see any broken or damaged parts, please immediately contact an expert to replace this element. Sharp edges of glass might cause serious damage.



DEUTSCH

VORSICHT

Das Umkippen der Möbel kann sehr schlimme Schäden am Körper anrichten, im schlimmsten Falle auch zum Tod führen. Um das Umkippen der Möbel zu vermeiden, müssen sich diese auf einer ebenen Fläche befinden.

Nehmen Sie ebenfalls Acht auf Elemente aus Glas. Falls Sie zerbrochenes Glas sehen so nehmen Sie bitte Kontakt mit einem Spezialisten auf, um das mangelhafte Element auszutauschen. Scharfe Ränder können sehr schnell zur Verletzung führen.

FRANÇAIS

ATTENTION

La chute des meubles peut provoquer des lésions importantes ou la mort. Pour prévenir la chute d'un meuble, il faut le poser sur une surface nivelée.

Faites attention particulière sur les éléments vitrés de l'armoire. Lorsque vous remarquez des traces de la vitre cassée, contactez immédiatement le spécialiste pour la remplacer. Les arêtes vives de la vitre peuvent provoquer des lésions importantes.

POLSKI

UWAGA

Przewrócenie się mebla może doprowadzić do poważnych obrażeń lub śmierci. Aby zapobiec przewróceniu się mebla, należy postawić go na płaskiej powierzchni.

Należy zwrócić szczególną uwagę na szklane elementy mebla. Jeśli elementy te są pęknięte lub uszkodzone, należy skontaktować się z fachowcem, w celu wymiany uszkodzonego elementu. Ostre krawędzie szkła mogą spowodować poważne obrażenia ciała.

NEDERLANDS

WAARSCHUWING

Het omvallen van het meubel kan leiden tot ernstig letsel of de dood. Plaats het meubel op een egale ondergrond om omvallen te voorkomen.

Let in het bijzonder op glazen onderdelen van de kast. Als je barsten ontwaart, neem dan onmiddellijk contact op met een specialist om het onderdeel te vervangen. Scherpe glasranden kunnen ernstig letsel veroorzaken.

DANSK

BEMÆRK

Væltning af møbler kan medføre alvorlige legemsskader eller død. For at forhindre et møbel i at vælte skal det opstilles på en nivelleret overflade.

Læg særlig mærke til skabets glaspartier. Konstaterer du tegn på brud, skal du omgående rette henvendelse til en specialist med henblik på udskiftning af det givne element med et nyt. Rudens skarpe kanter kan medføre alvorlige legemsskader.

ITALIANO

ATTENZIONE

La caduta dei mobili può causare gravi lesioni o la morte. Per evitare la caduta del mobile si deve poggiarlo su una superficie livellata.

Prestare particolare attenzione agli elementi vetrati dell'armadio. Se noti segni di spaccatura contatta immediatamente uno specialista per sostituire l'elemento. I bordi taglienti del vetro possono causare gravi lesioni.

ESPAÑOL

ADVERTENCIA

Volcar los muebles puede provocar lesiones graves o muerte. Para evitar que los muebles vuelquen, hay que colocarlos en una superficie nivelada.

Por favor, preste especial atención a los elementos acristalados del armario. Si observa signos de grietas, contacte con un especialista, para reemplazar los elementos defectuosos. Los bordes afilados del vidrio, pueden provocar lesiones graves.

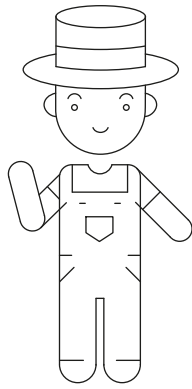
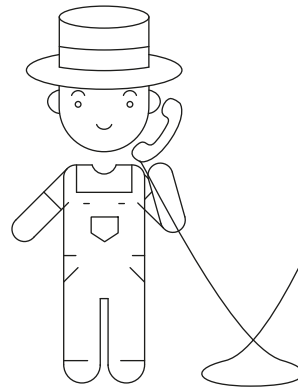
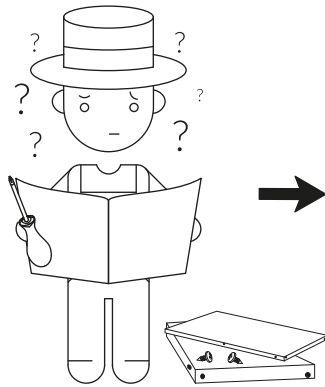
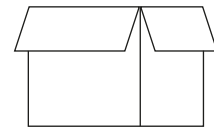

Diagram showing the required resources for the task:

- 1 worker (x1)
- 1 screwdriver (x1)
- 15-20 min



Jan Nowak
by DOMATOR 24
PL +48 422 84 24



x12

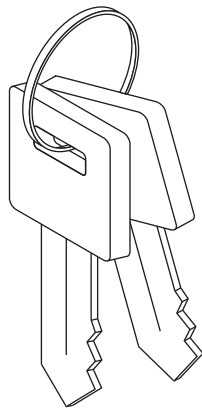

x1

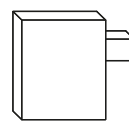

x16

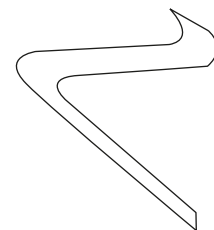

x16

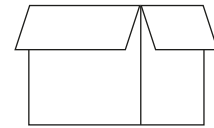

x1

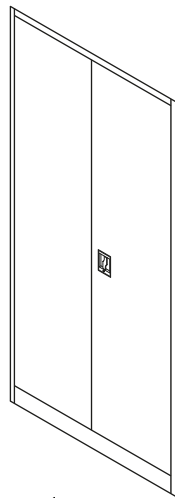

x1

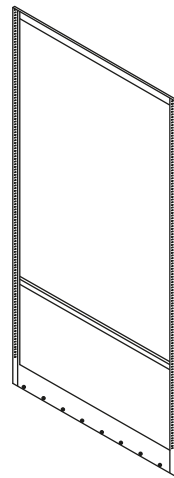

x1

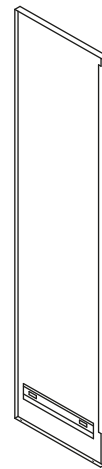

x1

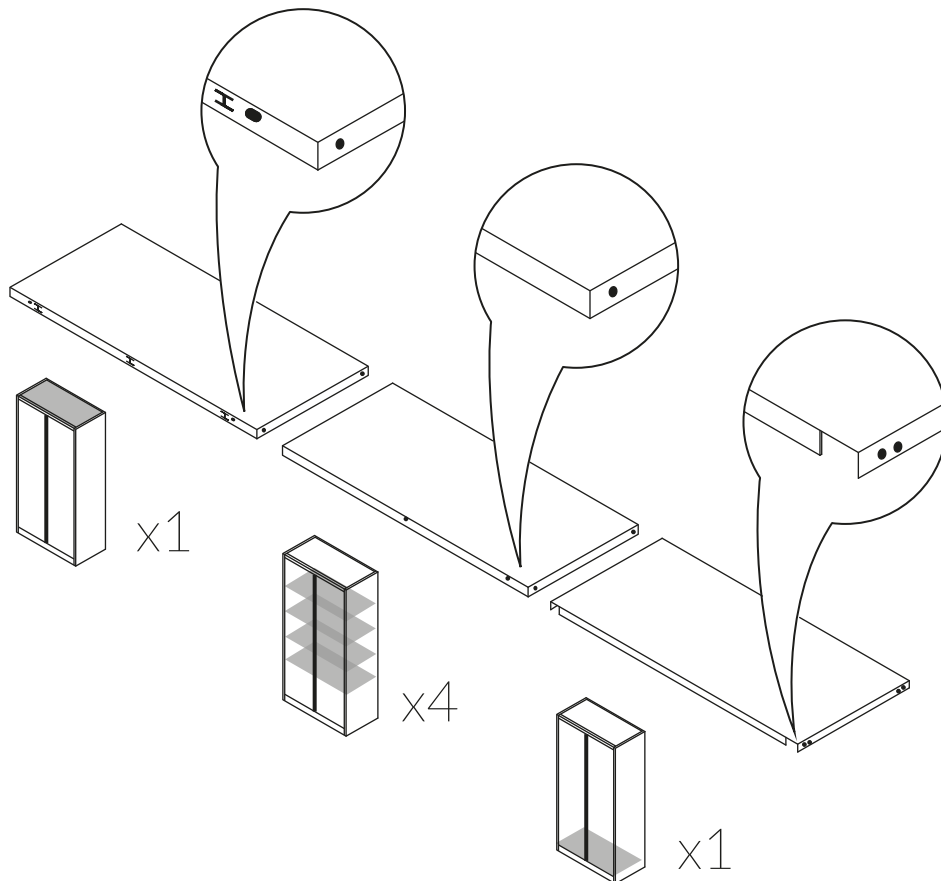
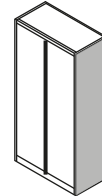
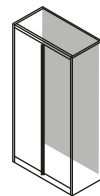
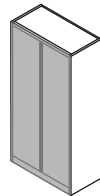
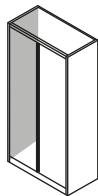

x1

x4

x1

1

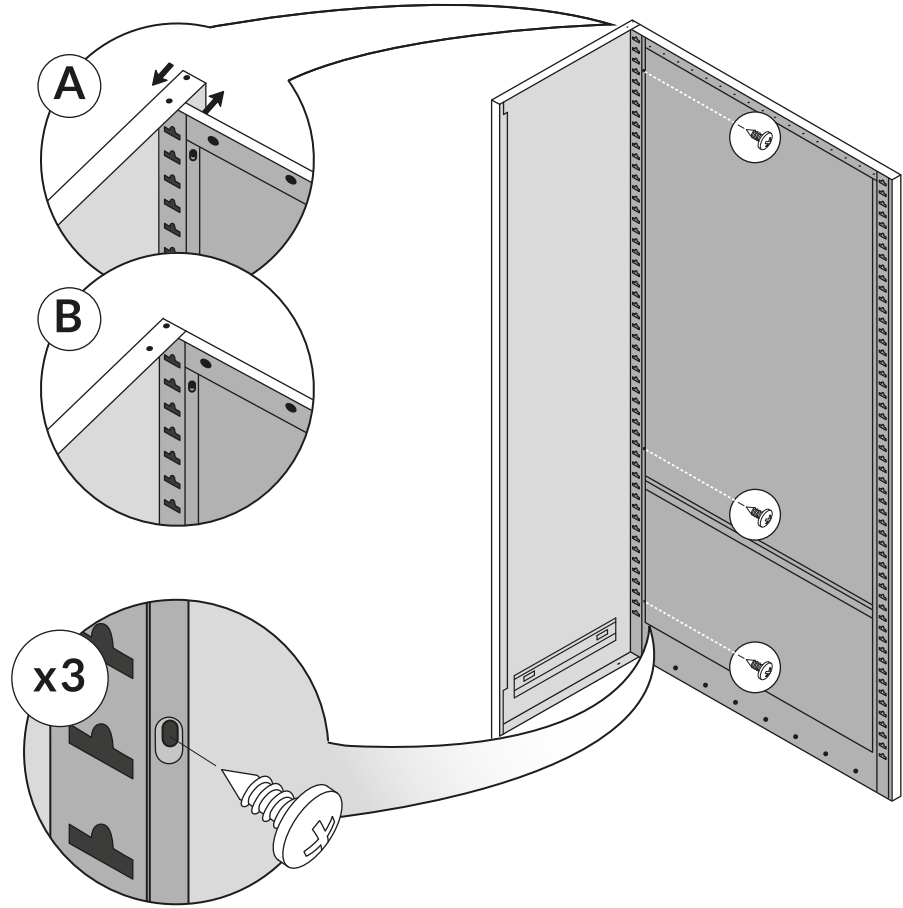

2

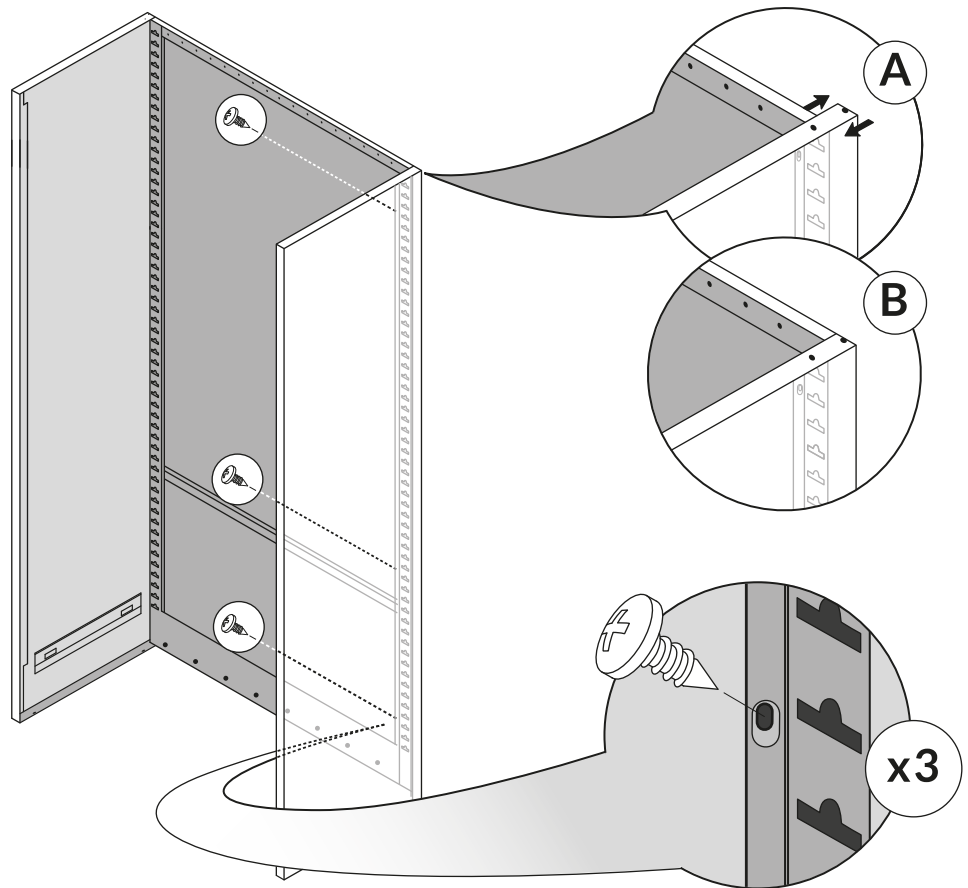

3

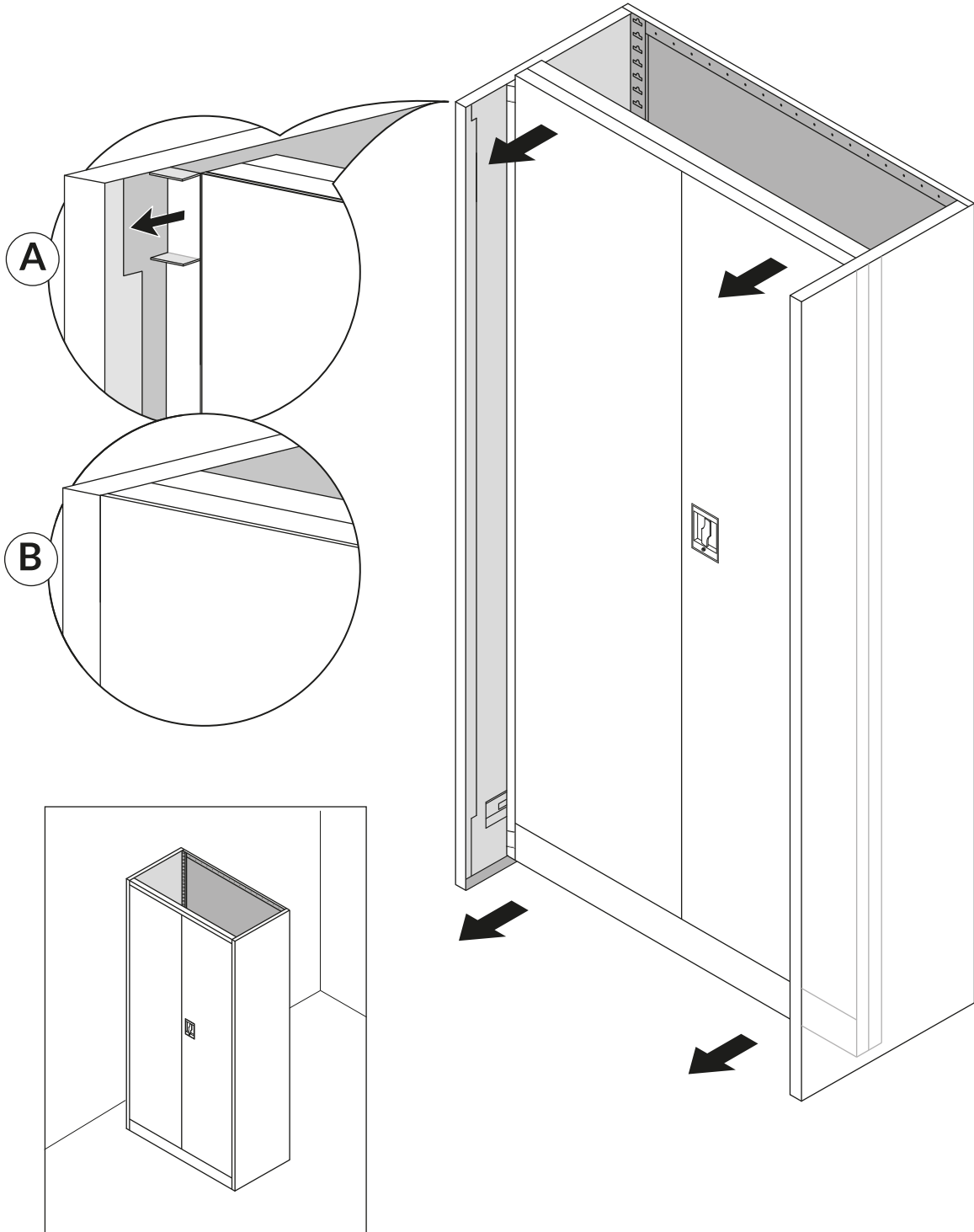

4

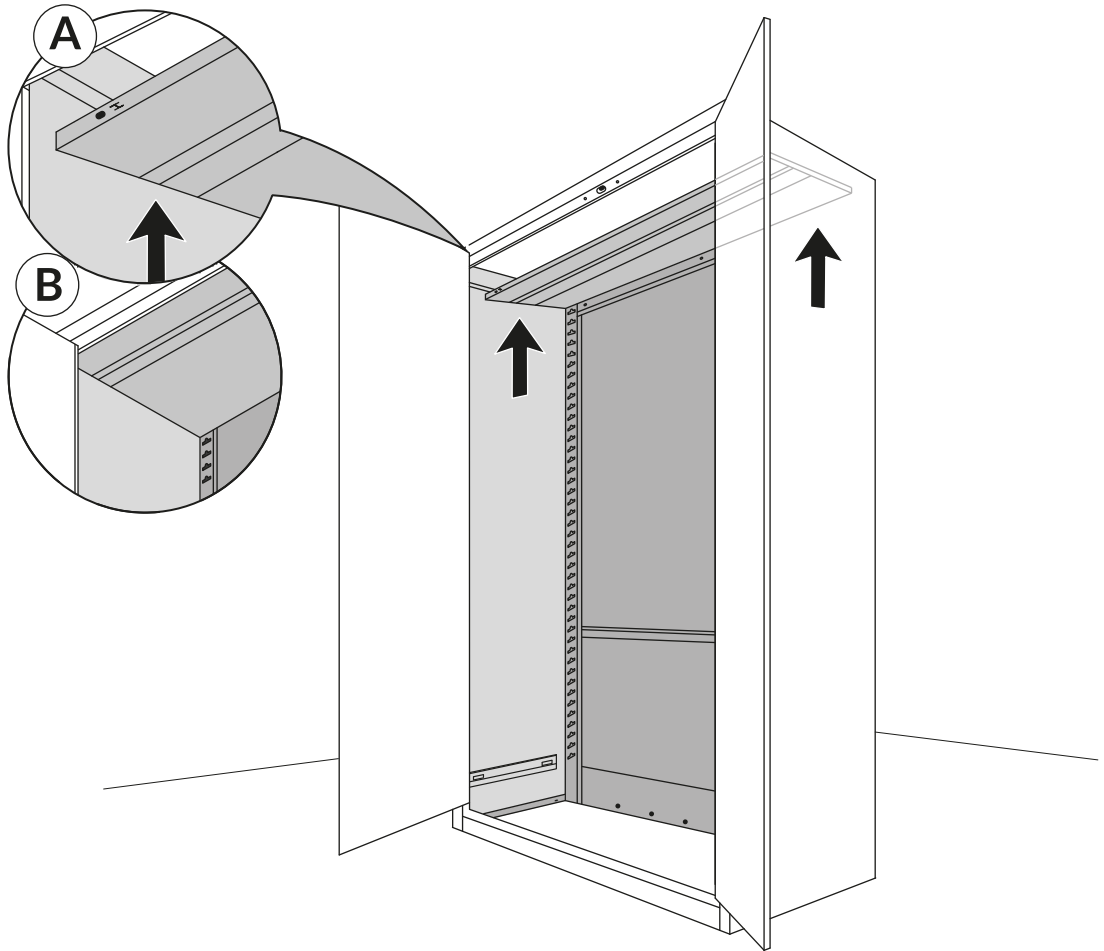

5

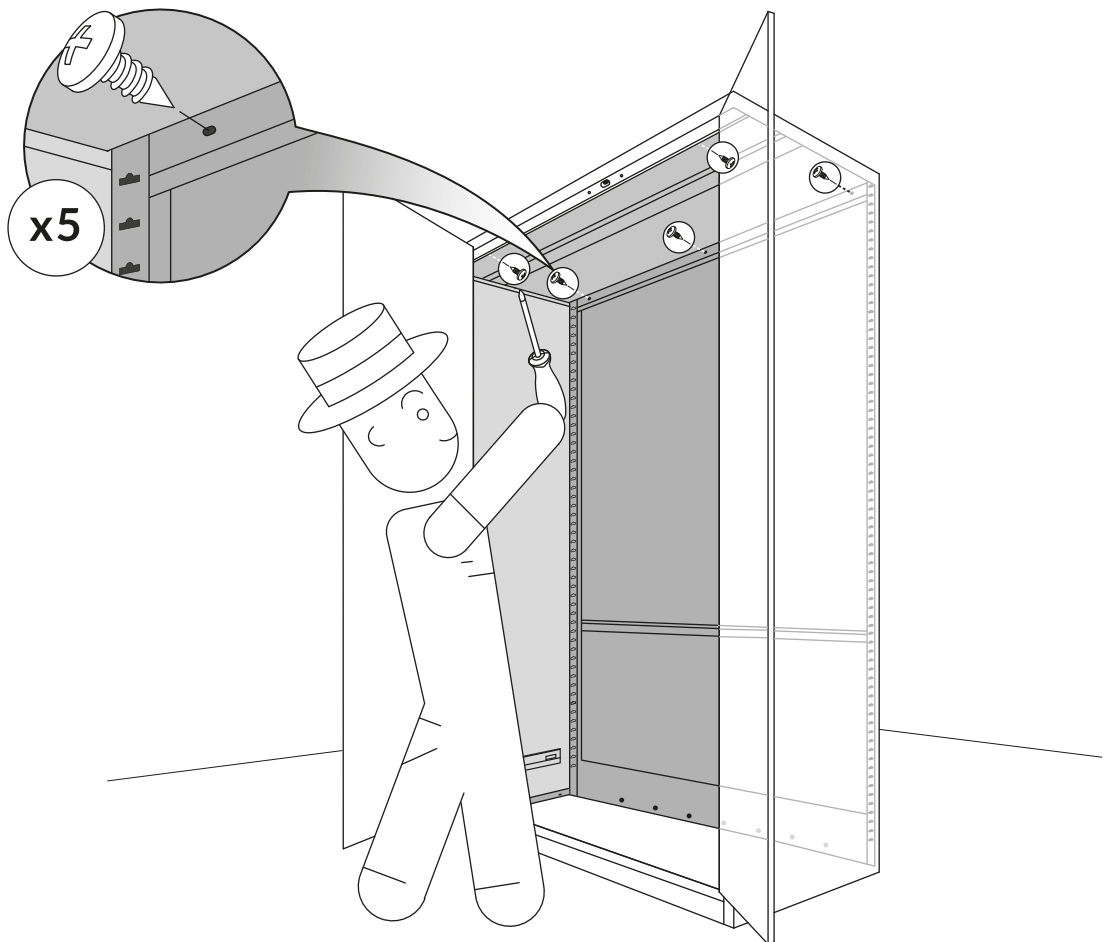

6

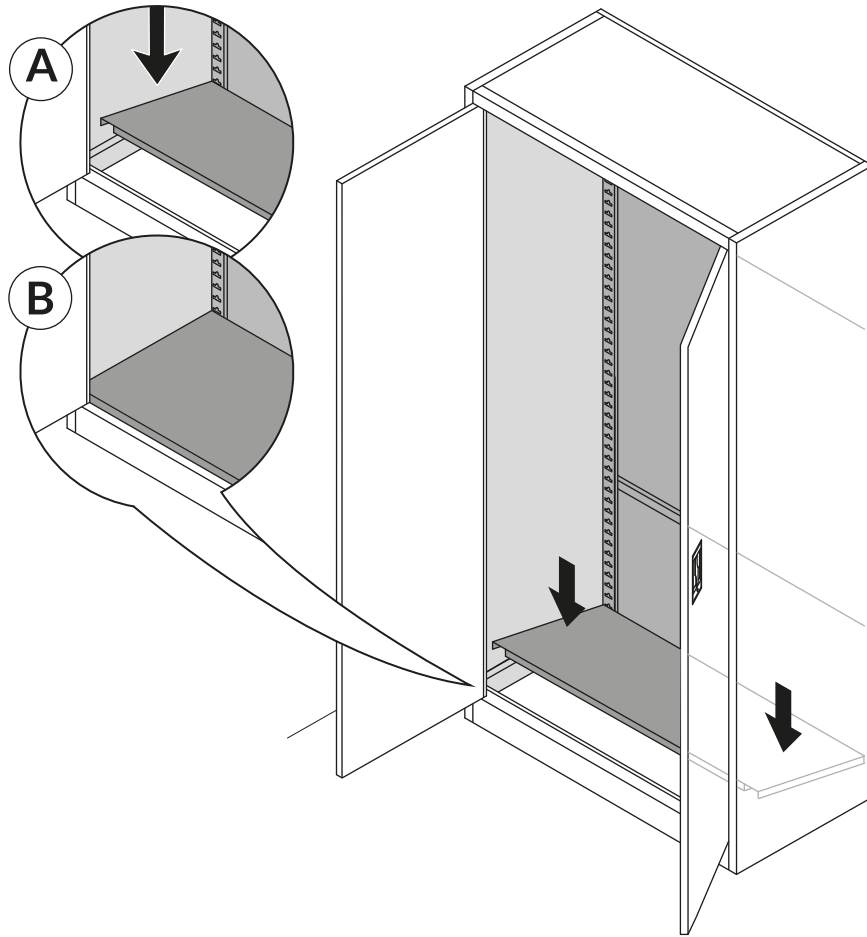

7

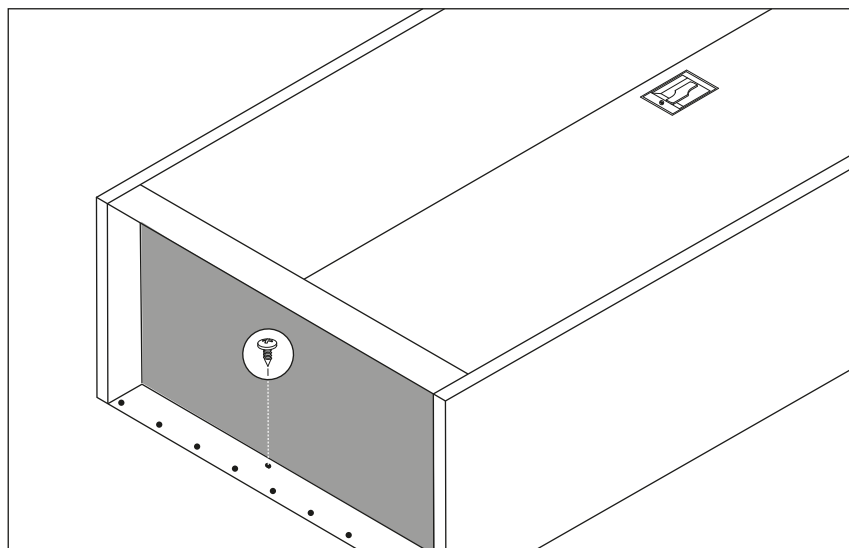
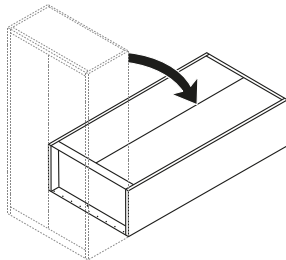

8

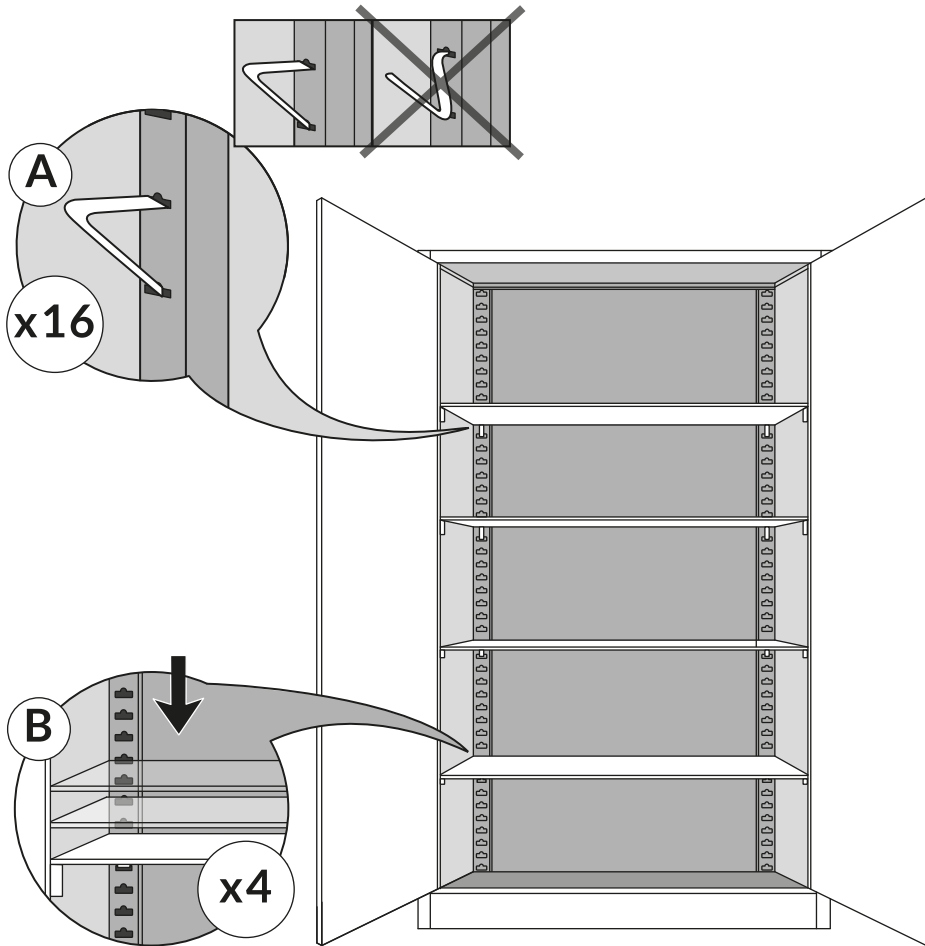

9

