

VISION

VISION03

0P-92

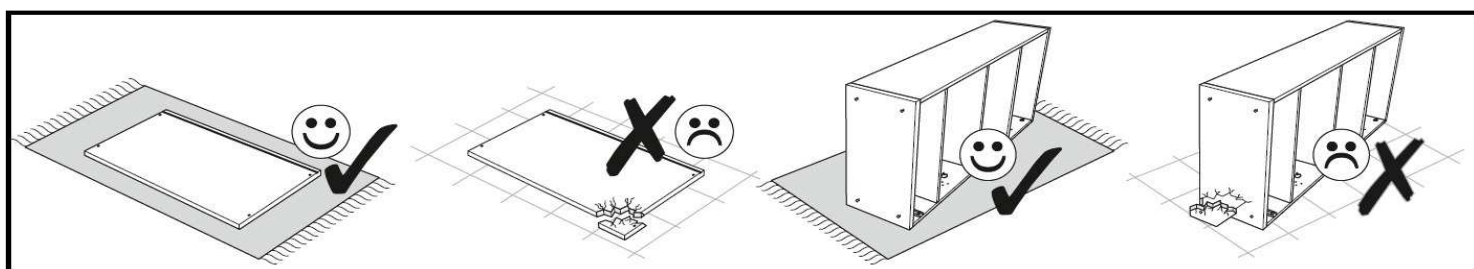
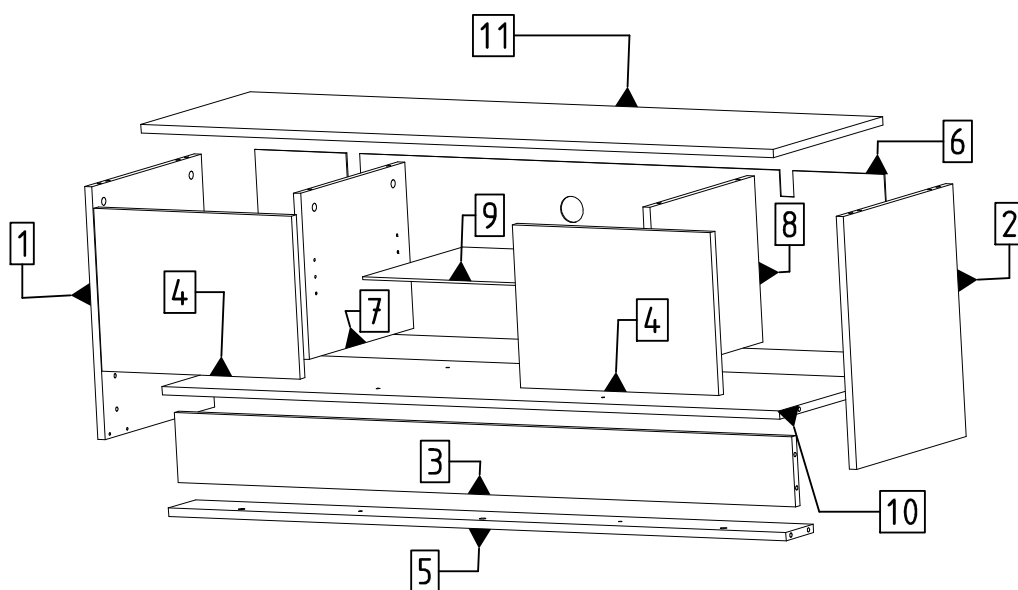
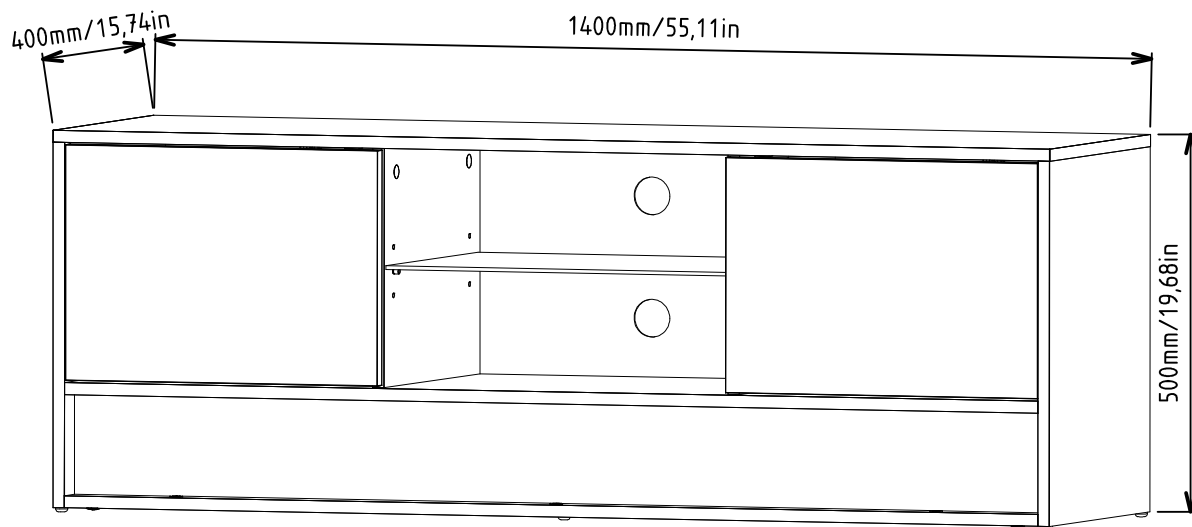
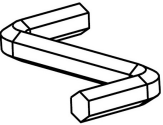
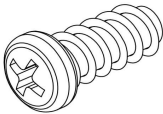
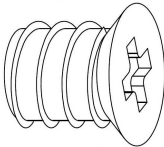
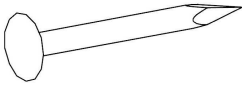
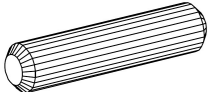
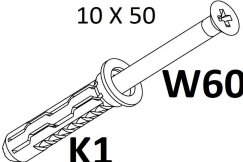
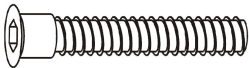
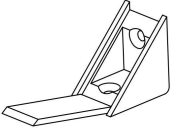
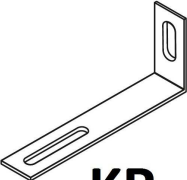

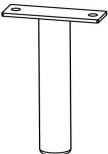
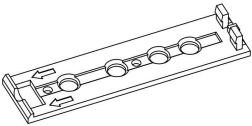
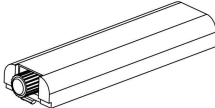
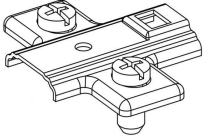
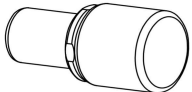
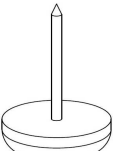
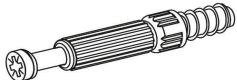

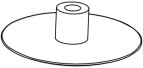
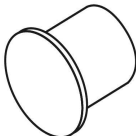
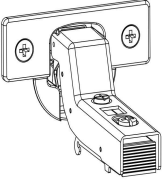
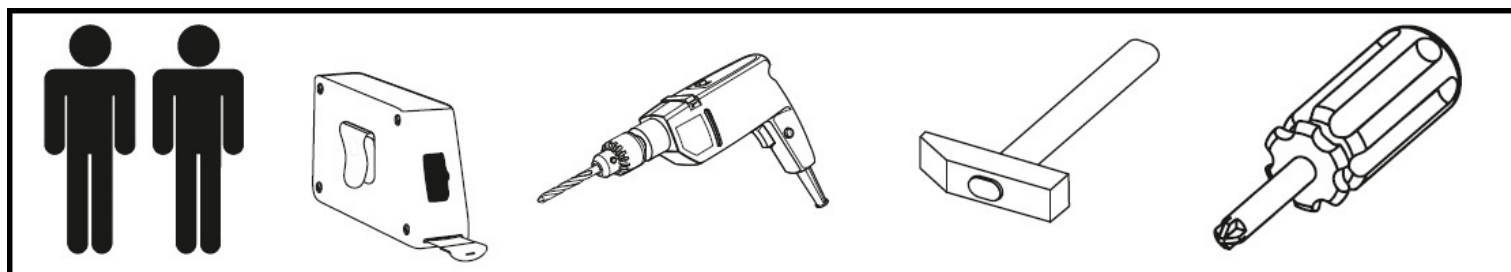

Table accessories

VISION03

 <p>A1</p>	<p>6,3 X 13</p>  <p>E13</p>	<p>6,3x9mm</p>  <p>E3</p>	 <p>G</p>	<p>8 x 30</p>  <p>K</p>
<p>10 X 50</p>  <p>K1</p>	<p>6,3 X 50</p>  <p>KN</p>	 <p>KP</p>	 <p>KR</p>	<p>15 x 12</p>  <p>M</p>
<p>H=156mm</p>  <p>N156</p>	 <p>OB</p>	 <p>OB2</p>	 <p>PE</p>	 <p>PP3</p>
 <p>SL</p>	<p>6 x 34 mm</p>  <p>T</p>	<p>4 x 16</p>  <p>W16</p>	 <p>Z</p>	 <p>Z5</p>
 <p>ZPWH</p>				

Elements				Accessories	
SYMBOL	LENGTH	WIDTH	QUANTITY	SYMBOL	QUANTITY
BL [1]	484	400	1	A1	1
BP [2]	484	400	1	E13	2
CD [3]	1367	134	1	E3	4
FT [4]	312	438	2	G	32
LD [5]	1367	100	1	K	8
PC [6]	1393	344	1	K1	2
PPI01 [7]	381	318	1	KN	6
PPI02 [8]	381	318	1	KP	1
PS [9]	481	366	1	KR	2
WD [10]	1367	400	1	M	16
WG [11]	1400	400	1	N156	1
				OB	2
				OB2	2
				PE	4
				PP3	4
				SL	5
				T	16
				W16	14
				W60	2
				Z	16
				Z5	8
				ZPWH	4



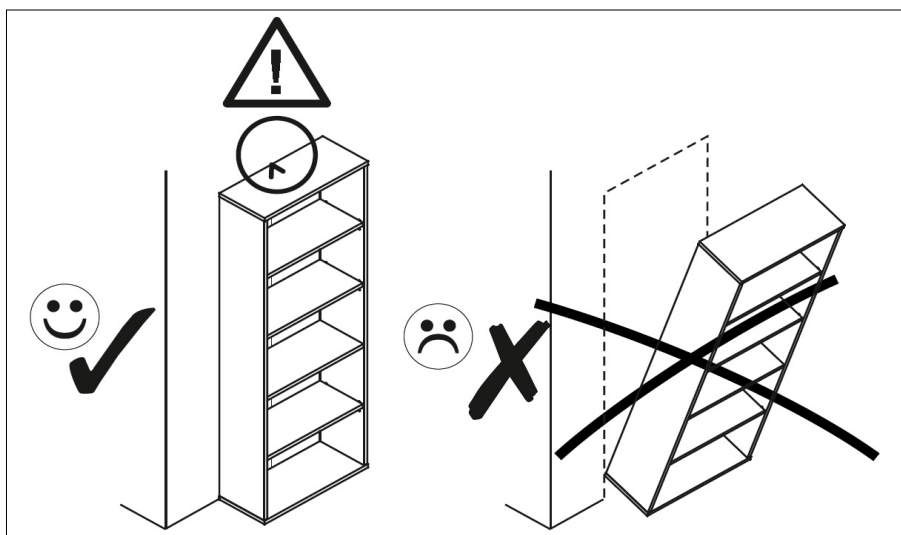

<p>PL UWAGA! Mebel trzeba trwale zamocować do ściany, aby uniknąć przewrócenia się mebla. W paczce są akcesoria przystosowane wyłącznie do ścian betonowych i z pełnej cegły. Jeśli nie jesteś pewien co do budowy ściany, skonsultuj się ze specjalistą.</p>	<p>EN ATTENTION! The furniture must be permanently attach to the wall, to avoid falling over furniture. There are accessories in the package adapted only to the walls concrete and solid brick. If you are not sure about the construction walls, consult expert.</p>	<p>RU ВНИМАНИЕ! Мебель должна быть постоянно прикрепить к стене, чтобы не упасть мебель. В упаковке есть аксессуара приспособлен только к стенам бетон и твердый кирпич. если Вы не уверены в конструкции стены, проконсультируйтесь специалист.</p>
<p>IT NOTA! I mobili devono essere permanenti attaccare al muro, per evitare di cadere mobili. Ci sono accessori nel pacchetto adattato solo alle pareti mattone concreto e solido. se non sei sicuro della costruzione muri, consultare specialista.</p>	<p>D ACHTUNG! Die Möbel müssen dauerhaft sein an der Wand befestigen, um nicht umzufallen Möbel. Es gibt Zubehör in der Verpackung nur an die Wände angepasst Beton und Vollziegel. wenn Sie sind sich nicht sicher über die Konstruktion Wände konsultieren Spezialist.</p>	<p>ES NOTA! La pieza necesita ser permanentemente pegar a la pared, para evitar caerse muebles. Estan en el paquete accesorios adaptados solo para paredes Hormigón y ladrillo macizo. si no estás seguro de la construcción Paredes, consultar a un especialista.</p>
<p>FR REMARQUE! La pièce doit être en permanence attacher au mur, pour éviter de tomber meubles. Ils sont dans le paquet accessoires adaptés seulement pour les murs béton et brique pleine. si vous n'êtes pas sûr de la construction murs, consultez un spécialiste.</p>	<p>CZ POZOR! Kus musí být natrvalo připevnit ke zdi, aby se zabránilo pádu nábytek. Jsou v balení příslušenství přizpůsobené pouze pro stěny betonové a pevné cihly. pokud Nejste si jisti stavbou konzultovat odborníka.</p>	<p>SLO POZOR! Kus musí být natrvalo pripojit' k stene, aby sa zabránilo pádu nábytok. Sú v balení príslušenstvo prispôsobené len pre steny betón a pevné tehly. ak Nie ste si istý stavbou konzultujte s odborníkom.</p>

1.

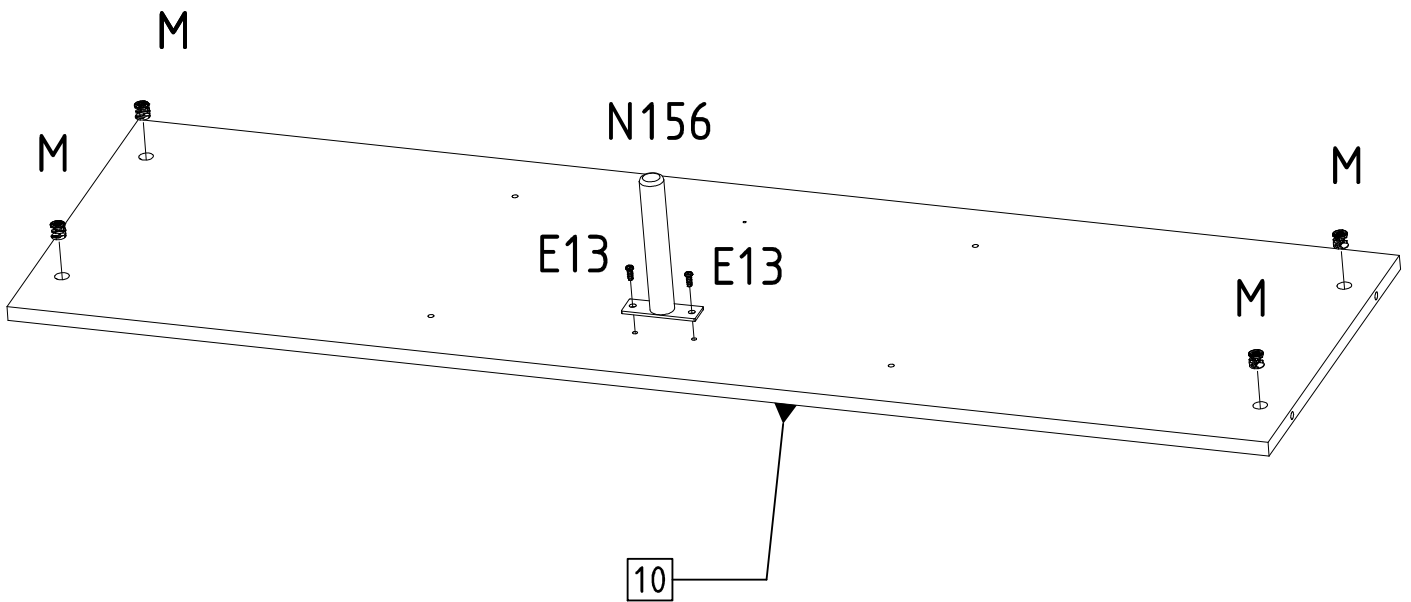
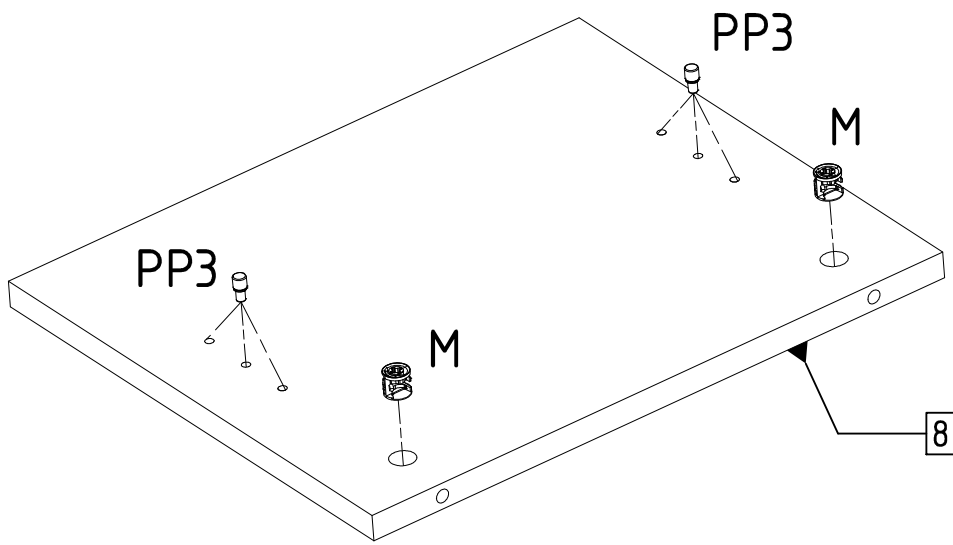
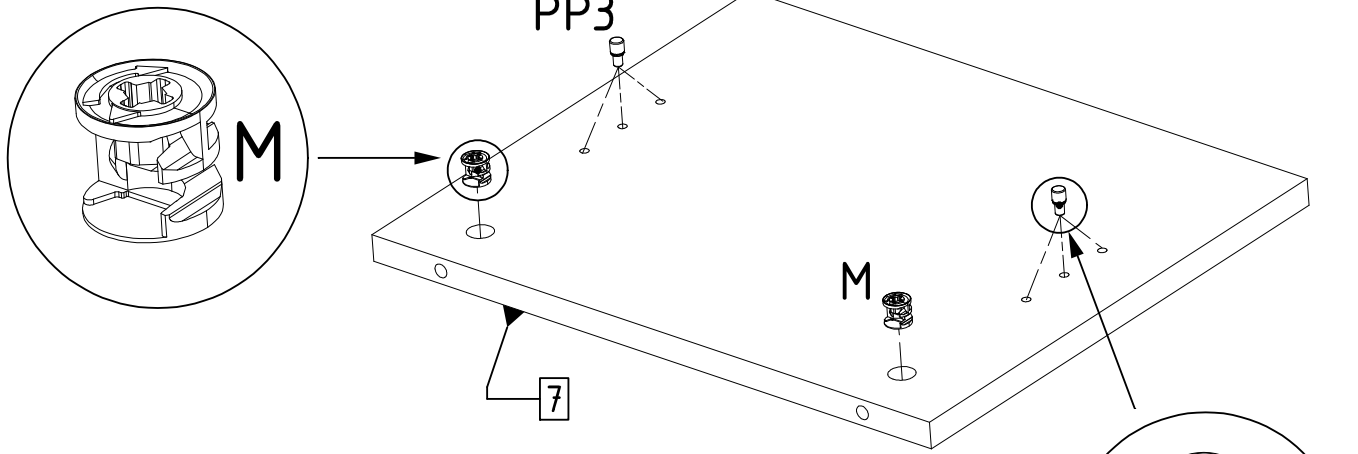

2.

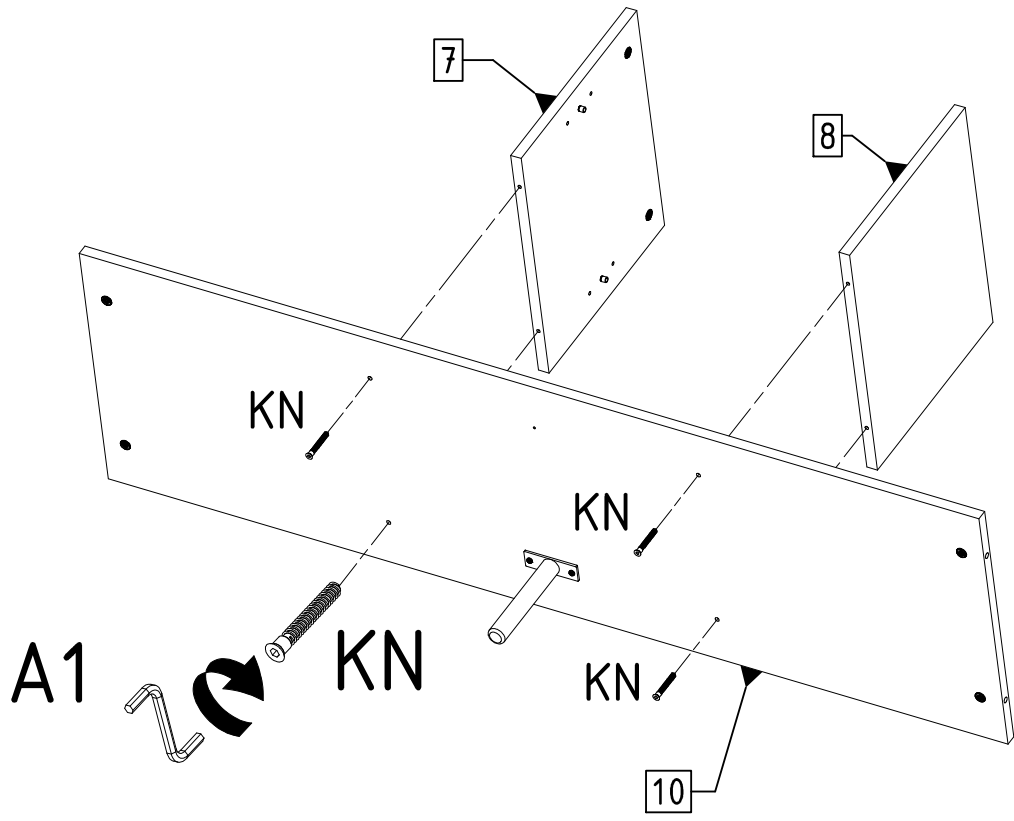

3.

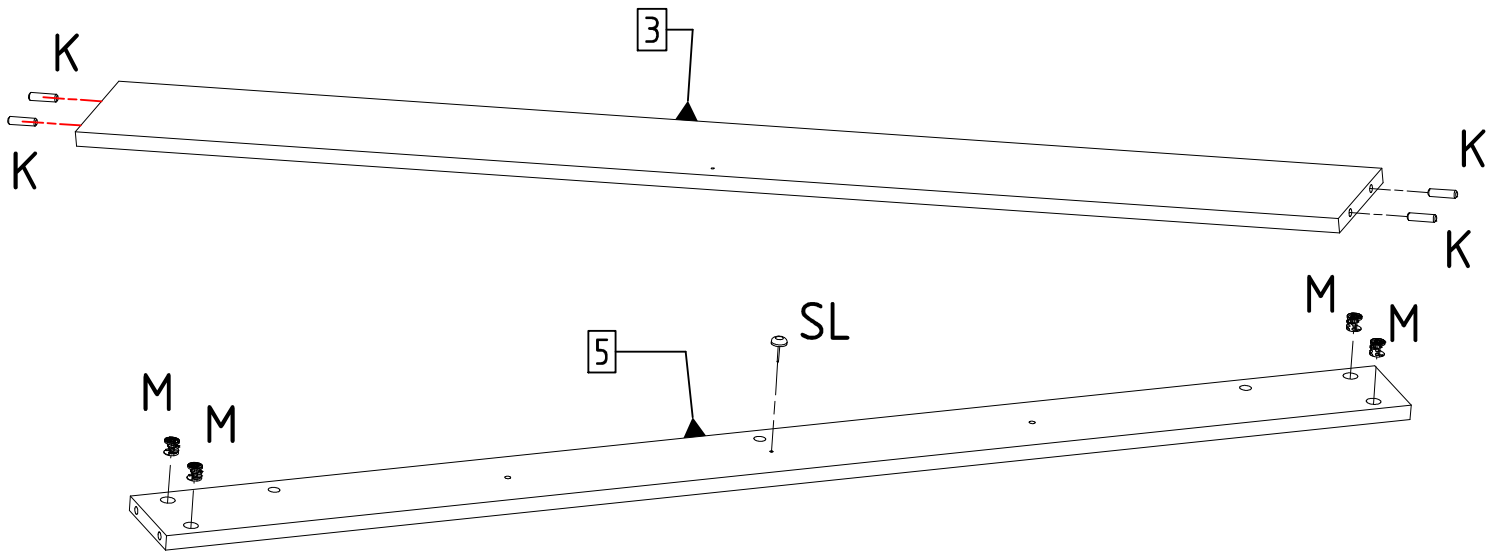

4.

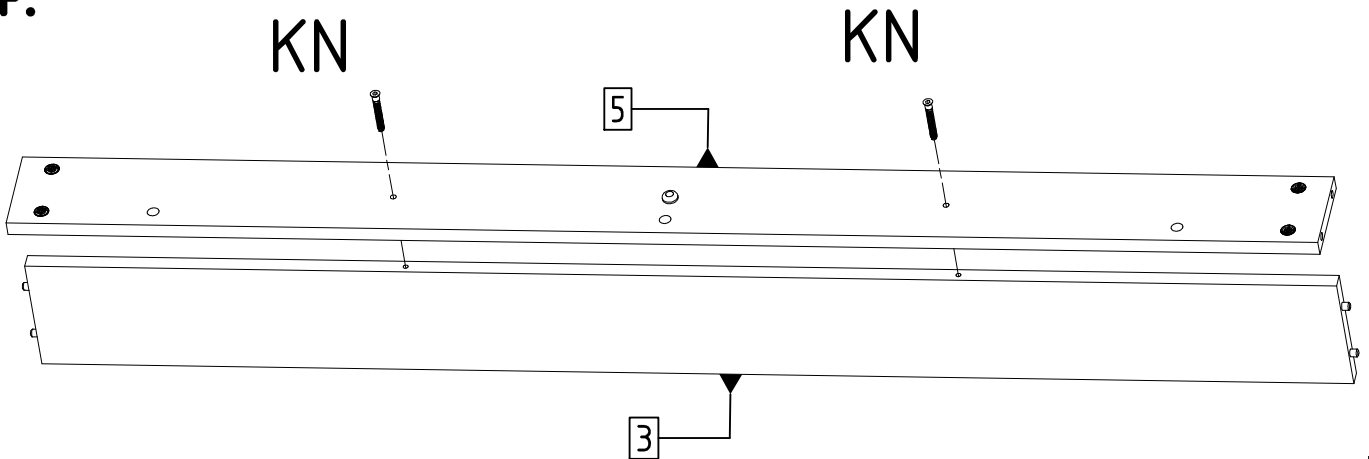

5.

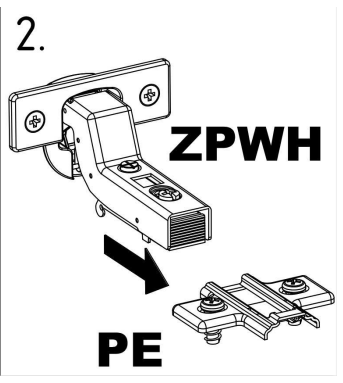
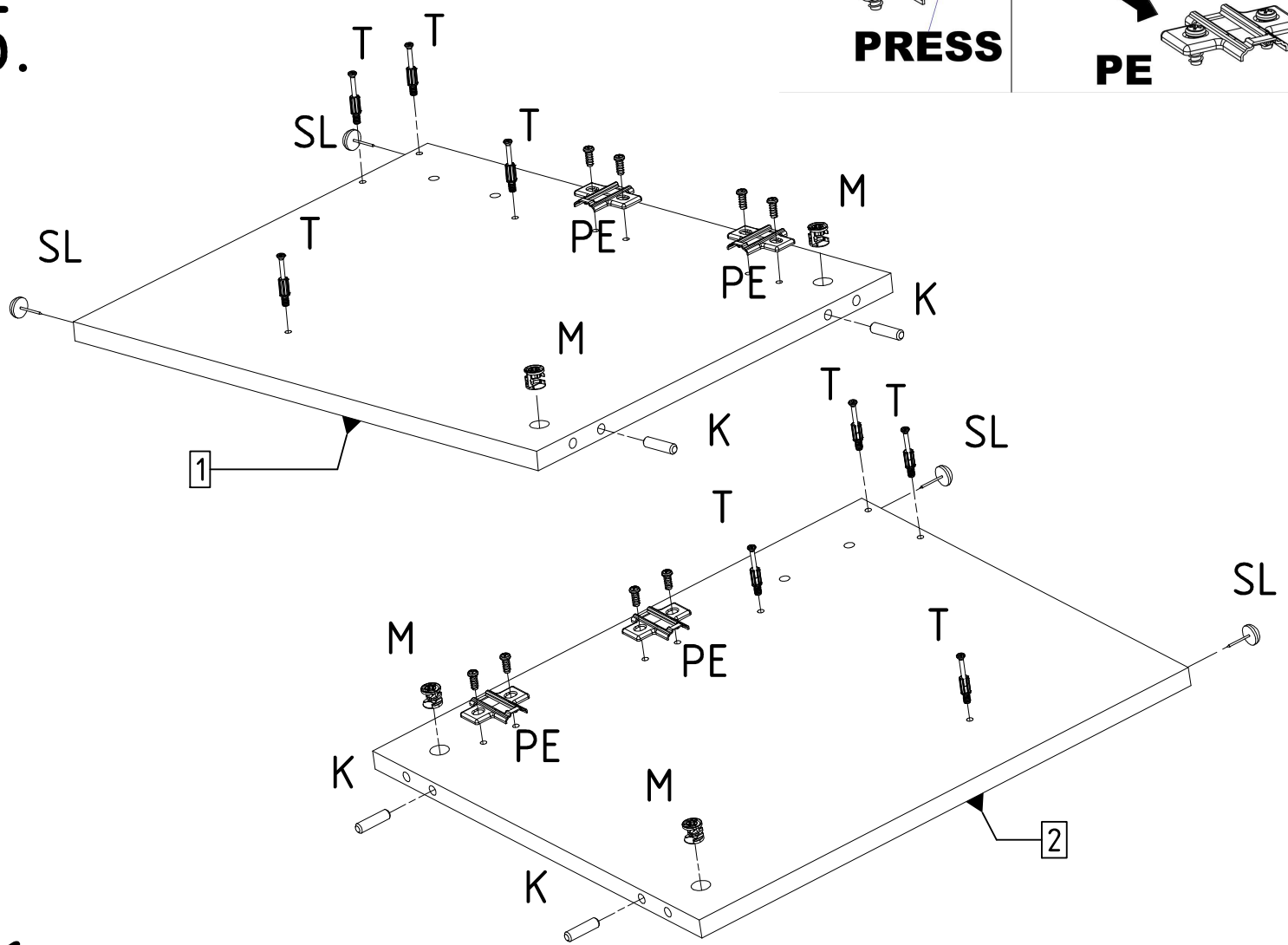

6.

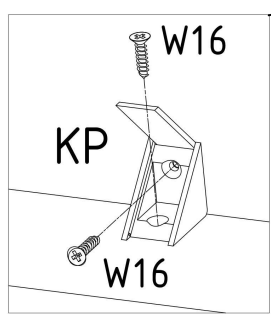
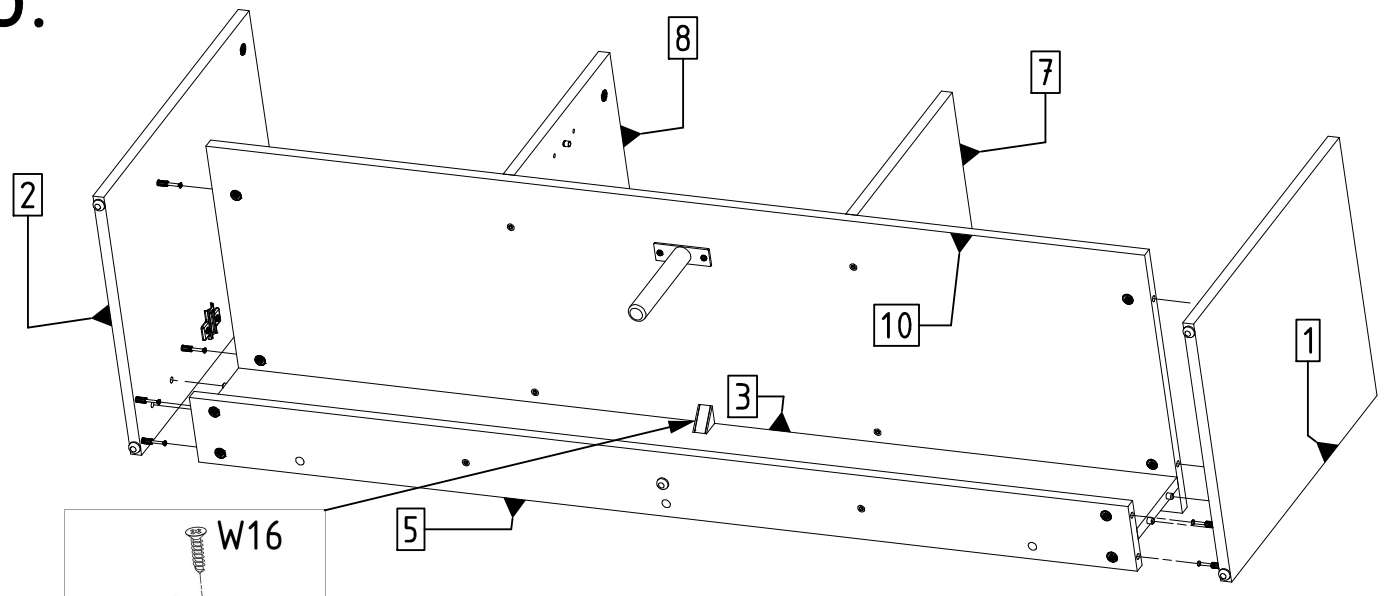

10.

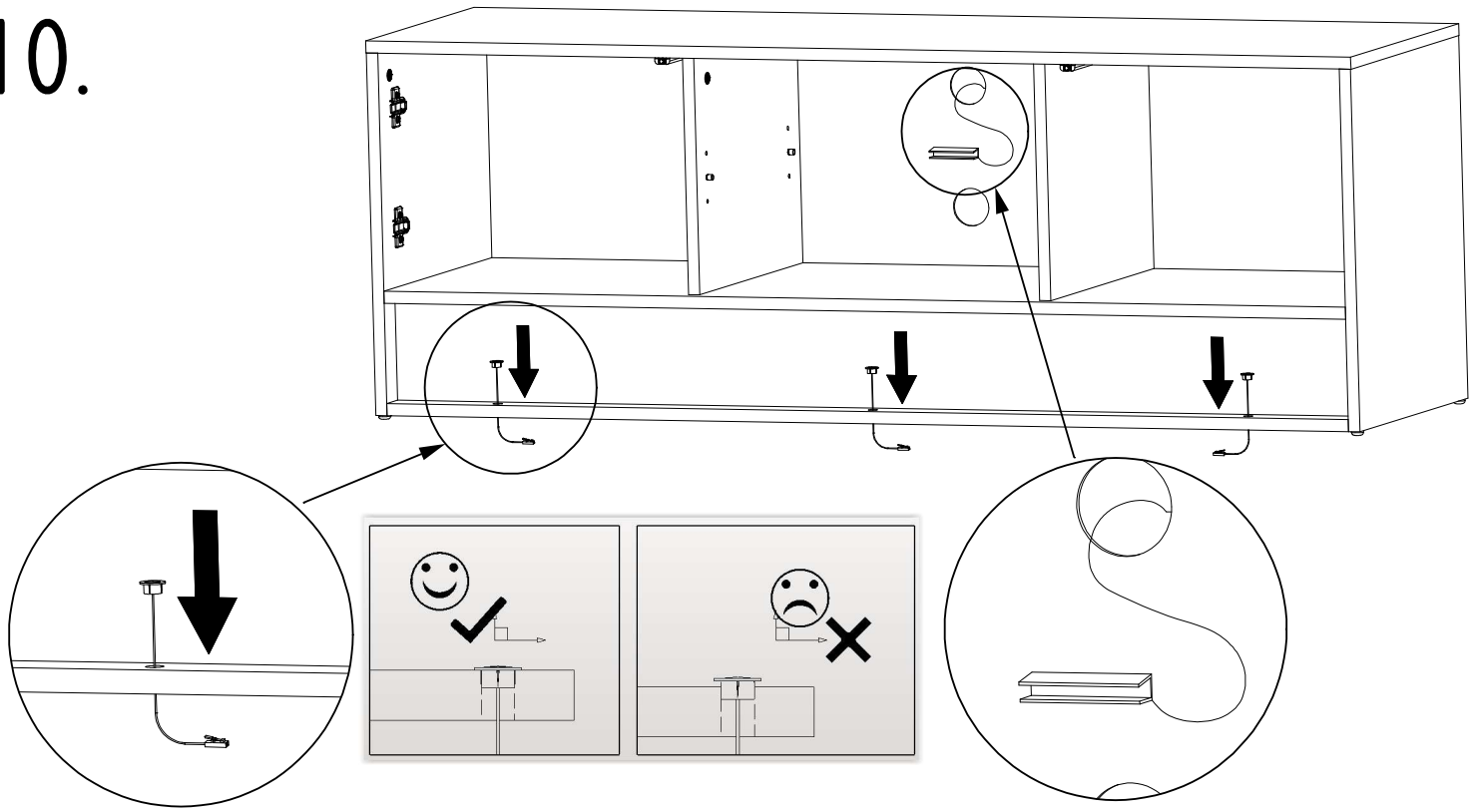

11.

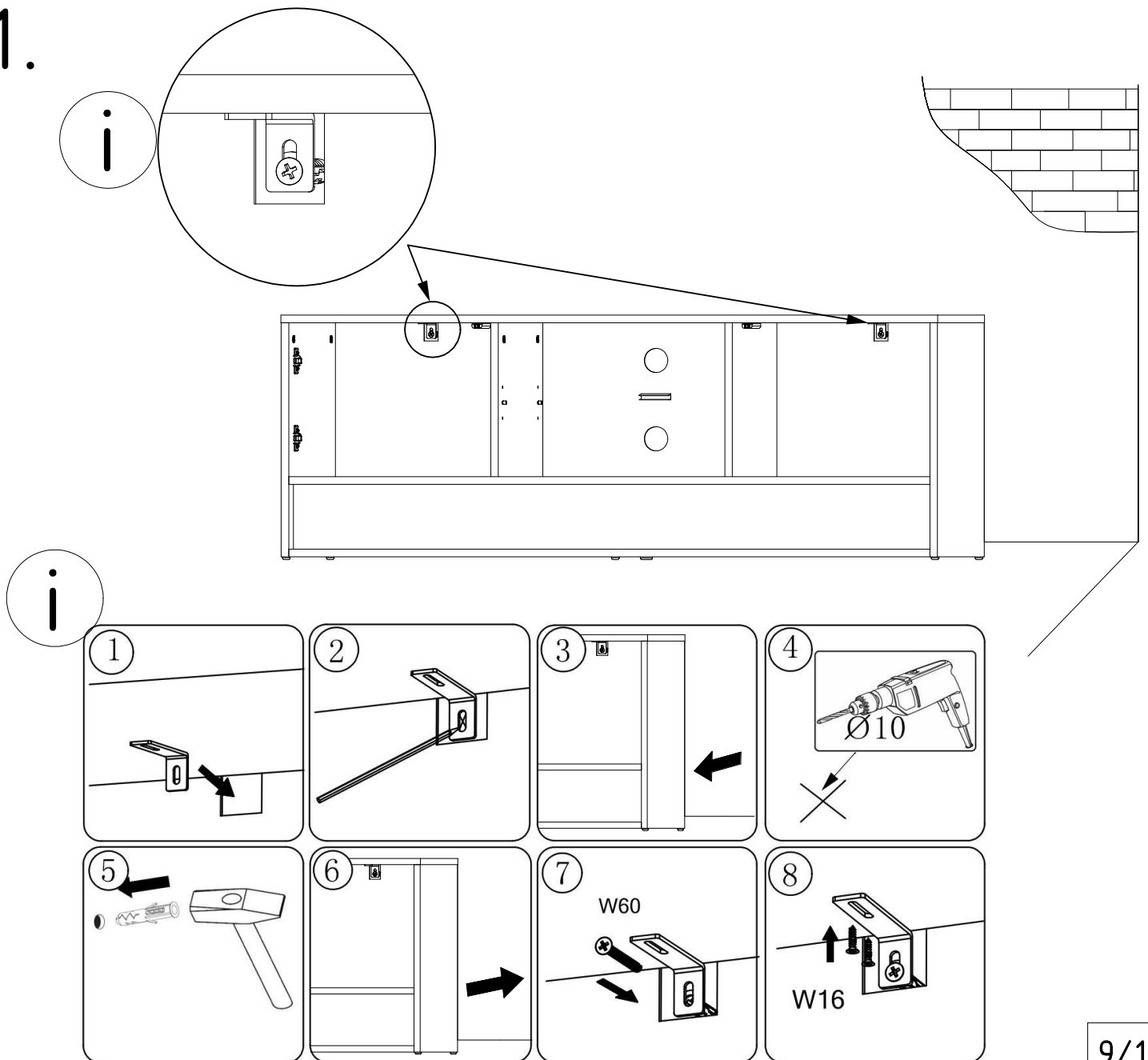

12.

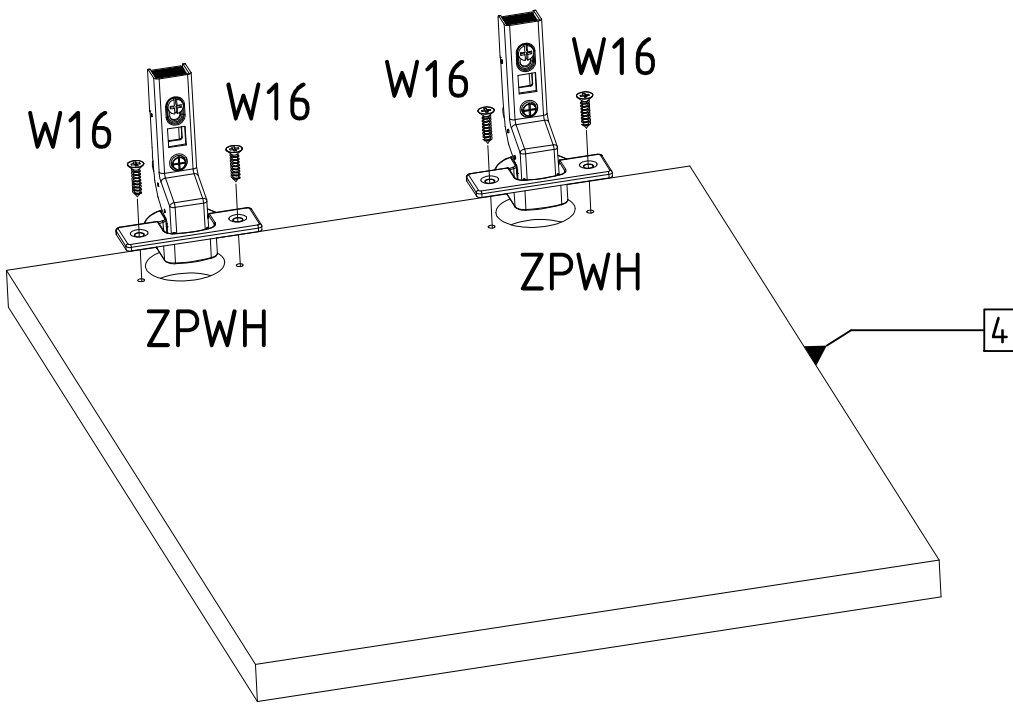

13.

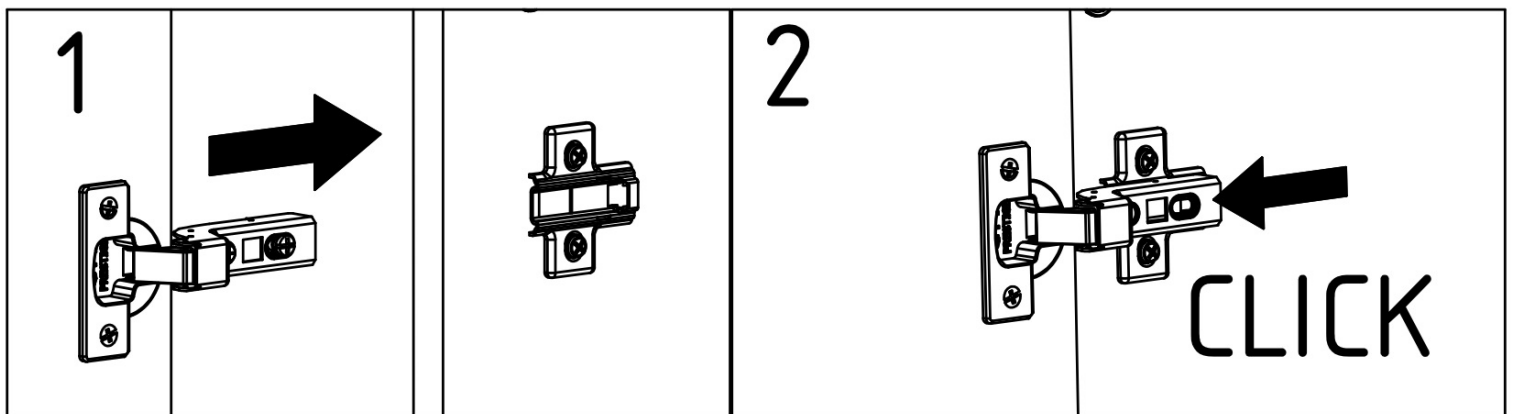
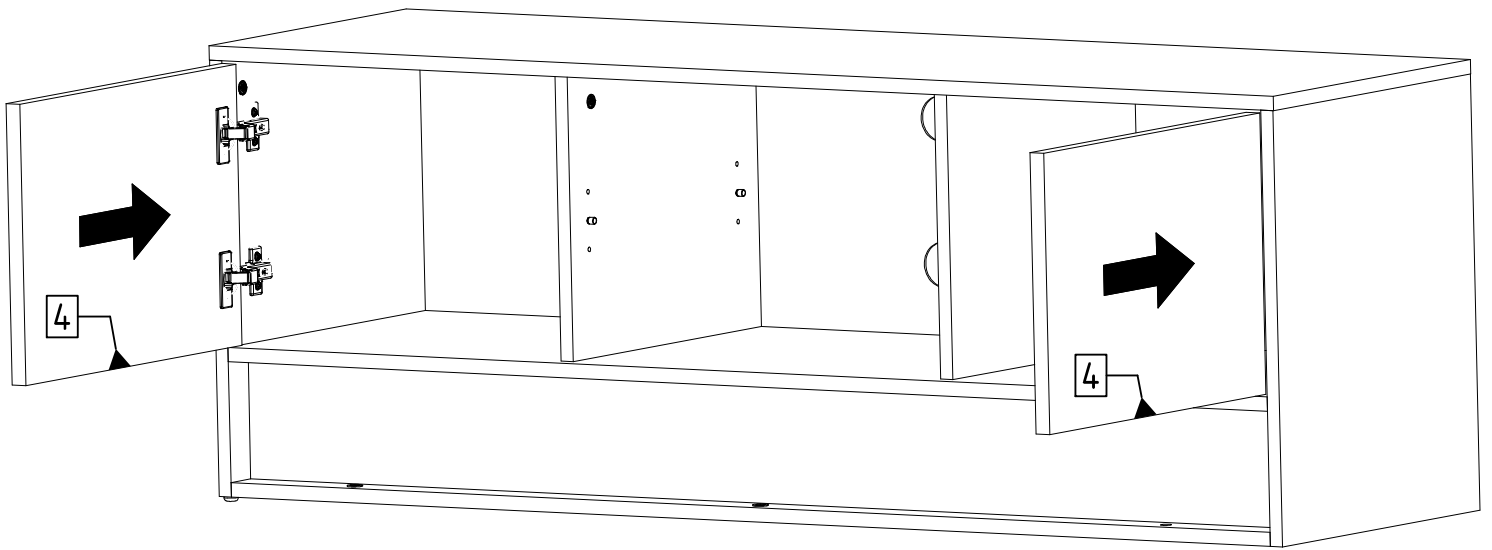

14.

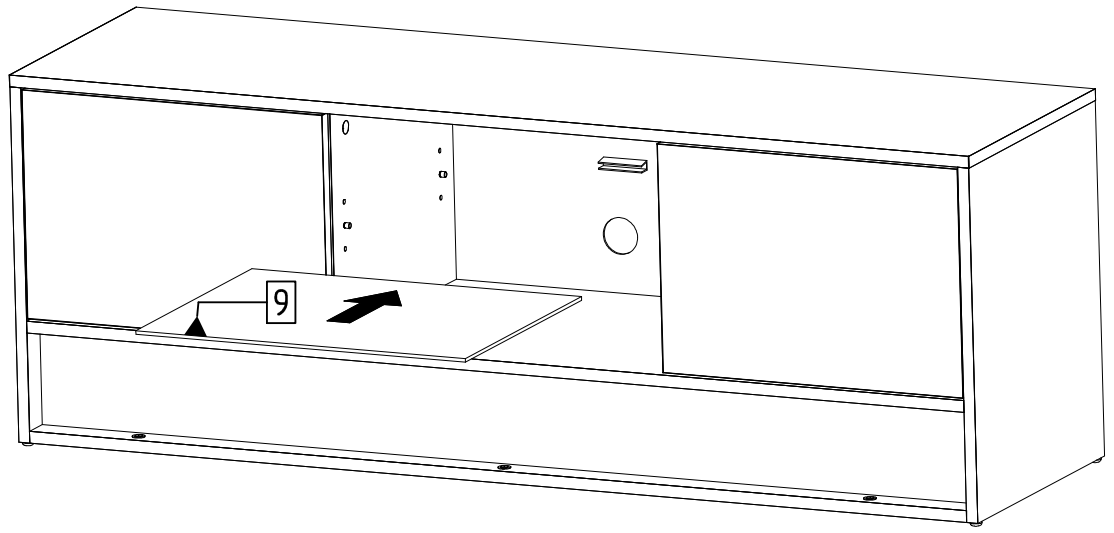
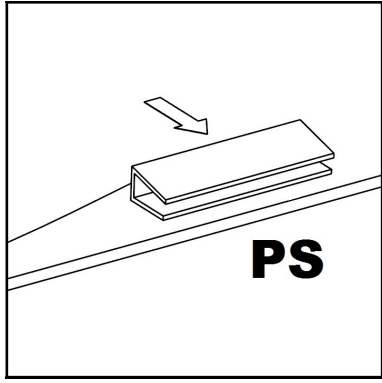

15.

